



Installation and Operation Manual for Perenio® Elegance IoT Routers

(Model: PEJIR01)

April, 2023

Introduction

Perenio[®] Elegance Multifunction IoT Router is a device that combines functions of a Wi-Fi/LTE Router and a Control Gateway, and in such a way is designed to transfer data between different network segments, as well as to monitor and manage operation of all sensors and other connected smart home devices. It is used as part of the **Perenio Smart** building management system or as a standalone device and ensures a reliable wireless data transmission.

The present Manual contains a detailed description of the device, as well as instructions for its installation and operation.

Copyrights

Copyright of ©Perenio IoT spol s r.o. All rights reserved.

The **Perenio[®]** trademark is owned by *Perenio IoT spol s r.o.* (hereinafter referred to as the *Perenio IoT*). All other similar trademarks and names, as well as logos and other symbols are the property of their respective owners*.

All materials under **Perenio[®]** tradename contained therein are protected in accordance with international and local laws including Acts on Copyrights and related rights.

Any reproduction, copying, publication, as well as further distribution or public display of materials contained in the present document (whether in full or in part) shall not be allowed until an appropriate permission of the copyright owner is obtained.

Any unauthorized usage of materials contained herein may lead to civil liability and criminal prosecution in accordance with applicable laws.

Any eventual mentioning of other company names and equipment in the present document is made solely for the purpose of clarifying and describing the device operation and shall not infringe on the third party's intellectual property rights.

***ZIGBEE** is the registered trademark of *ZigBee Alliance*; **Bluetooth** is the registered trademark of *BLUETOOTH SIG, INC.*; **LTE** is the registered trademark of *ETSI*; **Z-Wave** is the registered trademark of *SIGMA DESIGNS, INC.*; **iOS** is the registered trademark of *CISCO TECHNOLOGY, INC.*; **Android** is the registered trademark of *Google Inc.*; **Google Play** is the trademark of *Google Inc.*; **App Store** is the registered trademark of *Apple Inc.*; **Linux** is the registered trademark of *Linus Torvalds*.

Responsibility and Technical Support

The present document is prepared in accordance with all necessary requirements and contains detailed information on the device installation, configuration and control valid as of the date of its issue.

Perenio IoT reserves the right to modify the device and make corrections or changes to this document without prior notice of the User, and shall not be responsible for any potential negative consequences which may arise from the use of an outdated version of the document, as well as for any possible technical and/or typographical errors, either omitted or accidental, or any related damage that may result from the document transfer or the use of devices.

Perenio IoT shall make no guarantee with respect to any data contained herein including but not limited to the device merchantability and fitness for a particular purpose.

In case of any discrepancies between language versions of this document, the Russian version of this User Manual shall prevail.

For any technical issues, please contact your local *Perenio IoT* representative or the Tech Support Department at **perenio.com**.

The most common problems may be found in Section 8 of the present document and at **perenio.com** where you can also download the latest version of this Installation and Operation Manual.

Manufacturer:

Perenio IoT spol s r.o.

Na Dlouhem 79, Ricany – Jazlovice 251 01, Czech Republic

perenio.com

Conformance to Standards



The device is CE certified and complies with requirements of the following Directives of the European Union:

- 2014/53/EU Radio Equipment Directive (RED);
- 2014/35/EU Low Voltage Directive;
- 2004/30/EU Electromagnetic Compatibility Directive;
- 2009/125/EU Eco-Design Directive.



The device has passed all procedures of assessments established in Technical Regulations of the Customs Union and conforms with standards of the Customs Union



The device complies with the requirements of Restriction of the Use of Certain Hazardous Substances in Electronic and Electrical Equipment (2011/65/EU Directive) as specified in 2015/863



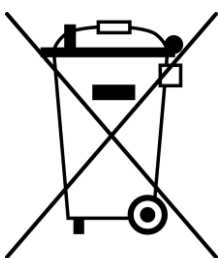
The device complies with requirements of the Technical Regulations of the Republic of Belarus TR 2018/024/BY (Telecommunications. Security)



The external power source complies with STB 2463-2020 where requirements for the environmental design of external power sources in the area of average effective efficiency and power consumption in idle mode are established



The national conformity mark of the Ukraine indicating that the device meets requirements of all applicable technical regulations



The crossed-out trash can symbol is used to label electrical and electronic equipment, and indicates its separate collection.

The symbol is given in accordance with the Directive 2012/19/EU on Waste Electrical and Electronic Equipment (WEEE)* and indicates that this equipment requires separate collection at the end of its life and must be disposed of separately from unsorted household waste.

To protect the environment and human health, please dispose of used electrical and electronic equipment according to approved safe disposal guidelines

Also, the device complies with the following technical regulations:

- TR TS 004/2011 on Low-voltage equipment safety;
- TR TS 020/2011 on Electromagnetic compatibility of hardware;
- TR EAEU 037/2016 on Restrictions for hazardous substances in electrical products and radio electronics.

Information about the certificates received is indicated in section 7 of this document. Copies of certificates and declarations can be found in the appropriate section on the website **perenio.com**.

Warnings and Restrictions

Prior to installation and operation of the device, the User shall carefully read and understand information contained herein.

ATTENTION! All Products and the Mobile Application of the Company (including any future software and hardware whether in-house or third-party developed) are not intended for emergency responses and cannot be used as fire-extinguishing equipment and/or for emergency intervention, including but not limited to fires, flooding, gas leaks or explosions, burglary and theft, as well as natural disasters and other force majeure circumstances leading to damage and/or losses incurred by the Client or caused to their estates, personal property and/or other products, devices, personal data and privacy.

Restrictions Related to Device

It is not recommended to install the device in areas with a high level of noise and a high-frequency interference. Reinforced concrete floors may reduce distance of wireless signal transmission.

Rates and distances of wireless transmission specified herein are the maximum values. The manufacturer does not provide any guarantees, either express or implied, with respect to such values since it may depend on various environmental factors, local interference, network congestion, traffic characteristics, connection quality, etc.

See also par 1.6 "Safe Operation Rules".

Limitations on the Use of a Built-in Battery

To extend the battery life and avoid potential hazards, the User shall:

- Prevent short circuit of the battery;
- Not expose the battery to temperatures below zero during operation of the device;
- Prevent the battery from heating above +60 °C;
- Charge the battery on a regular basis (at least once every 6 months);
- Prevent depressurization of the battery;
- Use the original battery model only.

For a completely discharged battery, it is impossible to switch on the IoT Router immediately after connecting it to the mains. Therefore, the User must charge the battery before switching on the IoT Router for the first time, or in the case when the device is not used for a long time.

Only original power adapters and cables may be used to charge the battery. The use of incompatible power adapters and cables may cause the battery to explode or damage the IoT Router, and will void the manufacturer's warranty.

Power Adapter Limitations

Using a non-original or incompatible power adapter, or improperly connecting it to the device may void the manufacturer's warranty, as well as lead to damages of the device, or risk of fire, or other hazards.

Both the device and the power adapter may become warm during charging. This is considered normal and does not have any adverse effect on the life and performance of the device. In case of excessive heating, corresponding indication of the power button will activate (See Table 1 below), so that the User shall let the device cool down by disconnecting it from the mains.

Since the power adapter is not equipped with a switch, it is recommended to disconnect it from the mains when not in use in order to save power.

Bandwidth Limitations

Some of the frequency bands supported by the device may not be available in your country or region. For more information, contact your local service provider.

Limitations on the Use of 5 GHz Networks

Devices operating within the range of 5,150 MHz to 5,350 MHz can only be used indoors due to the risk of affecting operation of satellite mobile communications systems.



AT	BA	BG	CZ	HR
LT	LV	PL	SK	
5150MHz to 5350MHz. For indoor use only.				

Table of Contents

Introduction	3
Copyrights	3
Responsibility and Technical Support	4
Conformance to Standards	5
Warnings and Restrictions	6
Table of Contents	9
1 General Description and Specifications	14
1.1 Device Purpose	14
1.2 Identification and Configuration	24
1.2.1 RAM and Flash Memory	25
1.2.2 Antennas and the Wi-Fi Cass	25
1.2.3 Built-In Battery	26
1.2.4 LTE, Bluetooth, ZigBee and Z-Wave Modules	26
1.3 Technical Specification	29
1.4 Scope of Delivery	32
1.5 Packaging and Labelling	33
1.6 Safe Operation Rules	33
2 Installation and Setup	35
2.1 Initial Installation and Configuration	35
2.1.1 Switching on and Booting Up	35
2.1.2 Initial Setting-Up	36
2.1.3 First Firmware Update	43
2.1.4 Activation in the Perenio Smart App	43
2.1.5 Area Selection and Installation	45
2.1.6 External Antenna Assembling	47
2.1.7 Inserting Nano-SIM Card	47
2.1.8 Activation of the IoT Router in the Perenio Smart App	49
2.2 Resetting and Rebooting	54
2.3 Ethernet Connection	58

2.4 Wi-Fi Protected Setup (WPS).....	58
2.5 History and Push-Notifications.....	59
2.6 Armed Mode	60
2.7 The Use of USB Storage Devices.....	60
2.8 Upgrading and Downgrading Firmware	61
2.9 Log Downloading.....	62
2.10 Management of Wi-Fi Access Points.....	63
3 Admin Panel Interface	65
3.1 Login to the admin panel	65
3.2 Top Panel.....	66
3.3 Bottom Panel.....	68
3.4 Quick Setup.....	68
3.5 Advanced mode	68
3.6 Status Tab	69
3.6.1 Basic Buttons and Indicators.....	70
3.7 System Tab	71
3.7.1 System.....	72
3.7.2 Administration	73
3.7.3 Backup/Flash Firmware.....	74
3.8 Services Tab.....	76
3.8.1 Network Resources.....	76
3.9 Network Tab	77
3.9.1 Interfaces	77
3.9.2 Wi-Fi	78
3.9.3 Modem.....	79
3.9.4 Diagnostics	81
3.9.5 Firewall	81
3.9.6 Load Balancing	82
3.10 IoT Tab	84
4 Maintenance and Repair.....	86

5 Warranty Obligations	87
6 Storage, Transportation and Disposal of Devices	90
7 Other Information	91
8 Troubleshooting	92
9 Frequently Asked Questions	94
9.1 Safety Operation Rules	94
9.2 Cabling.....	94
9.3 Battery Operation	94
9.4 Remote Reset.....	94
9.5 SIM Card Configuration and Disabling the PIN Code	94
9.6 Changing Wi-Fi Network Name and Password.....	94
9.7 Sharing USB Flash Files	95
9.8 Time Zone and Time Synchronization.....	95
9.9 Using Multiple Internet Connections.....	95
9.10 Priority for Multiple Internet Connections	95
9.11 Activating the Device in the Mobile Application	95
9.12 Activating the device in Another Account in the Mobile App	95
9.13 Removing Device from Account in the Mobile App	95
9.14 Log Downloading.....	95
9.15 Disabling the Access Point	96
9.16 Manual Selection of the 3G Mode.....	96
10 Glossary	97

Figures

Figure 1 - Exterior.....	15
Figure 2 - Buttons, Ports and Indicators	15
Figure 3 – Self-Recovery of ZigBee Network.....	28
Figure 4 – Scope of Supply**	33
Figure 5 – Available colors of the power button after switching on the device.....	35
Figure 6 – The process of loading device modules.....	36

Figure 7 – Device operating mode indication option.....	36
Figure 8 – Example of the list of available Wi-Fi networks.....	36
Figure 9 – Example of the device information sticker	37
Figure 10 – Connection to the Internet outlet, mains socket and the laptop	38
Figure 11 - Examples of installation*	46
Figure 12 – Mounting holes.....	46
Figure 13 – Tightening the external antenna	47
Figure 14 – Removing the SIM Card holder from the casing.....	48
Figure 15 – Inserting the nano-SIM into the holder	48
Figure 16 – Activation process.....	54
Figure 17 – Location of the reset button	55
Figure 18 – Indicators after holding the reset button for 8 seconds.....	55
Figure 19 – Deactivation of the device in the mobile application	56
Figure 20 – The moment of reboot, when it is no longer possible to cancel the hard reset	57
Figure 21 – Location of the button to perform hard reset.....	57
Figure 22 – Login screen of the admin panel	66
Figure 23 – Icons and buttons in the top panel	66
Figure 24 – Icons in the bottom panel	68
Figure 25 – Location of buttons for quick setup and advanced mode	68
Figure 26 – Status tab Screen	69
Figure 27 – “System” – “System Properties” Screen	72
Figure 28 – Changing the admin panel password.....	73
Figure 29 – “System” – “Backup/Flash Firmware” Screen	74
Figure 30 – “Services” – “Network Shares” Screen	76
Figure 31 – “Network” – “Wireless” Screen.....	78
Figure 32 – “Network” – “Modem” Screen	80
Figure 33 – “Network” – “Modem settings” Screen	80
Figure 34 – “Network” – “Diagnostics” Screen	81
Figure 35 – “Network” – “Firewall” Screen.....	82

Tables

Table 1 – LED Indicator Statuses.....	17
Table 2 – Push button functionality	23
Table 3 – LTE Category description	27
Table 4 – Basic Technical Specifications.....	29
Table 5 – Buttons and indicators in the admin panel	70
Table 6 – Description of the main parameters of the “System” tab	72
Table 7 – Description of the main parameters of the “Control” tab	73
Table 8 – Description of the main parameters of the “Backup/Flash Firmware” tab ..	74
Table 9 – Description of the interface metric and weight settings	83
Table 10 – Typical Errors and Troubleshooting Methods	92

Connection to the Perenio Smart Mobile App

A. INSTALLATION OF THE PERENIO SMART MOBILE APP.....	49
B. DEVICE ACTIVATION BY QR CODE SCANNING.....	51
C. CONNECTING TO WI-FI NETWORK.....	52
D. LOCATION AND ROOM SETTING.....	53

1 General Description and Specifications

1.1 Device Purpose

Perenio® Elegance Multifunction IoT Router is a device that combines functions of a Wi-Fi/LTE Router and a Control Gateway that is designed to join operation of other devices within the **Perenio Smart** system, as well as to collect data and alert Users in the event of an alarm. The IoT Router searches for and manages devices via the Mobile App.

Key features of the device are as follows:

- Support of Wi-Fi, Ethernet, Bluetooth, Zigbee and/or Z-Wave*;
- Windows, MacOS, Linux, Ubuntu, iOS and Android user interface compatibility;
- Initial setup using smartphone/PC;
- Single-band or dual-band access point mode;
- Option for using nano-SIM*;
- External LTE Antenna*;
- Ability to quickly and safely configure a wireless network (WPS button);
- Stability of the wireless network due to automatic switching between Wi-Fi, Access Point Client and LTE modes of operation*;
- Switching the WAN Port to operate as a LAN Port;
- Ability to manually or automatically select a preferable 3G mode (UMTS-900 or UMTS-2100);
- Built-in battery operation of up to 6 hours*;
- Smart Battery mode*;
- Connection of up to 150 ZigBee devices*;
- Support for cloud services, data collection from and analysis of ZigBee devices;
- LED Indication of states;
- Built-in RTC module;
- Remote control via a free mobile application;
- Integration with video surveillance systems;
- Metal plate made of anodized aluminum.

* Some components, modules, and/or functions may not be available in your IoT Router configuration. See paragraph 1.2 below.



Figure 1 - Exterior

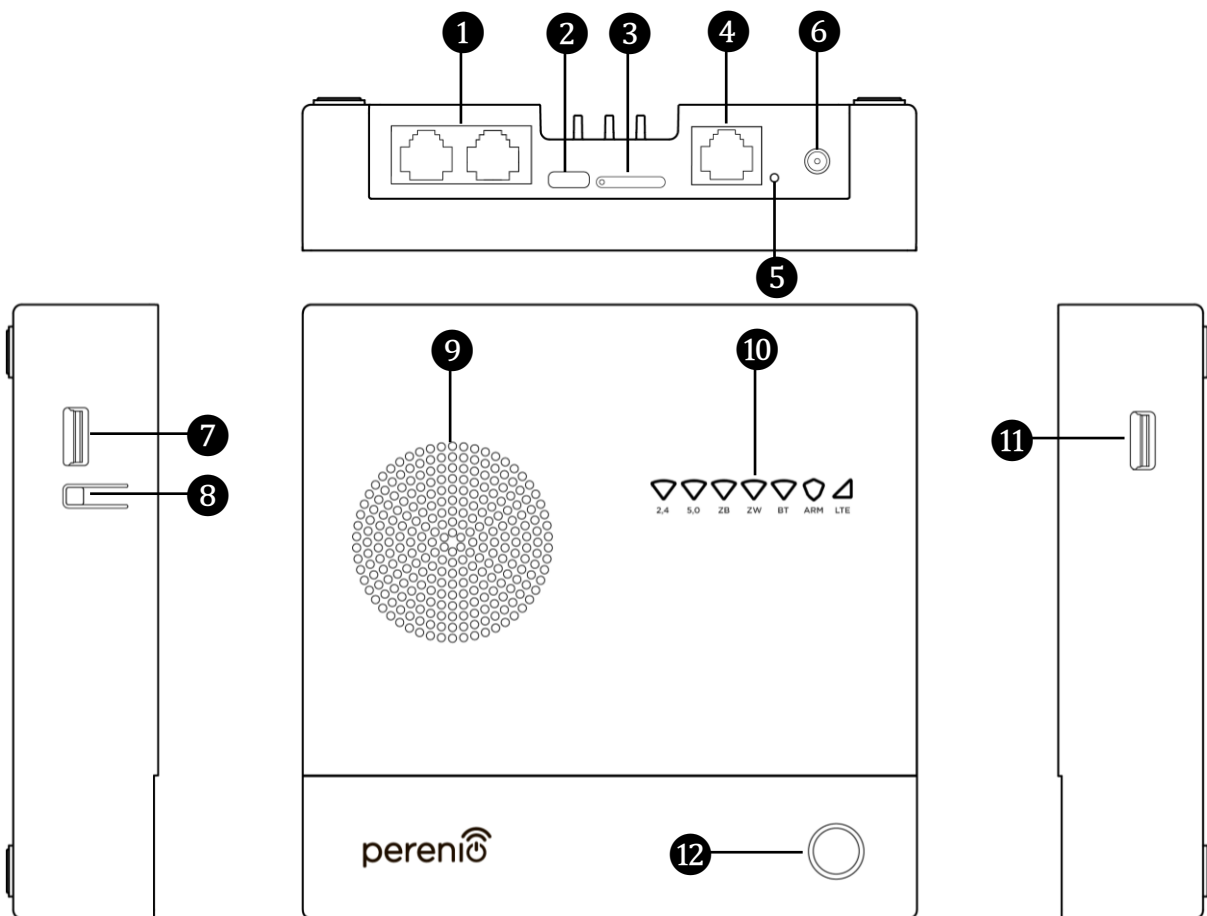


Figure 2 - Buttons, Ports and Indicators

Buttons, Ports and Indicators

- | | |
|----------------------------|---|
| 1 LAN Ports | Local network ports used to connect the IoT Router and other devices located close to each other (within an apartment or an office) |
| 2 Power Port | The port for connecting the IoT Router to the mains |
| 3 SIM Card Slot | Slot for the nano-SIM Card holder that is available in configurations with the LTE Module |
| 4 Internet/LAN Port | Global computer network port intended for the Internet provider network cable (The IoT Router gains access to the Internet via this cable). Also, this port can be used as a LAN Port |
| 5 Reset Button | The button used to reset various IoT Router settings made by the User (See details in par.2.2 below) |
| 6 LTE Antenna Port | Port for connecting an external antenna that is available in configurations with the LTE Module |
| 7 USB 3.0 Port | Port for the USB 3.0 cable or the USB storage |
| 8 WPS Button | The button used for quick wireless network setup |
| 9 Buzzer* | Built-in beeper, or ventilation holes |
| 10 LAN Indicators | Status indicators of IoT Router modules (See details in Table 1 below) |
| 11 USB 2.0 Port | Port for the USB 2.0 cable or the USB storage |
| 12 Power Button | The button used to turn on and off the IoT Router (See details in Table 1 below) |

* Some components, modules, and/or functions may not be available in your IoT Router configuration. See paragraph 1.2 below.


Table 1 – LED Indicator Statuses

Icon	Color	State	Description
2.4 (Wi-Fi Network of 2.4GHz)	Green	On	The module is enabled and used as an access point, but there is no data transmission
	Green	Blinking	The module is enabled and used as an access point, data transmission is in progress
	Aqua	On	The module is enabled and used as Client, but there is no data transmission
	Aqua	Blinking	The module is enabled and used as Client, data transmission is in progress
	Orange	On	The module is enabled and used as Client, but there is no data transmission or Internet connection
	Orange	Blinking	The module is enabled and used as Client, attempt for data transmission, but there is no Internet connection
	Yellow	On	The module is enabled and used as Client, poor quality of Internet connection, and no data transmission
	Yellow	Blinking	The module is enabled and used as Client, poor quality of Internet connection, data transmission is in progress
	Purple	Blinking	Ongoing process of network setup via WPS (starts blinking upon pressing the WPS button)
	White	On	The module is enabled and used as Client, Internet connection is not used, and there is no data transmission
	White	Blinking	The module is enabled and used as Client, Internet connection is not used, but data transmission is in progress
		Off	The module is disabled
	Red	On	The module error (Please contact our Tech Support Department)
Red	Blinking	The module error (Please perform reset to factory settings)	

Icon	Color	State	Description
5.0 (Wi-Fi Network of 5GHz)	Green	On	The module is enabled and used as an access point, but there is no data transmission
	Green	Blinking	The module is enabled and used as an access point, data transmission is in progress
	Green	Flickering	The module is enabled, radar searching is in progress
	Aqua	On	The module is enabled and used as Client, but there is no data transmission
	Aqua	Blinking	The module is enabled and used as Client, data transmission is in progress
	Orange	On	The module is enabled and used as Client, but there is no data transmission or Internet connection
	Orange	Blinking	The module is enabled and used as Client, attempt for data transmission, but there is no Internet connection
	Yellow	On	The module is enabled and used as Client, poor quality of Internet connection, and no data transmission
	Yellow	Blinking	The module is enabled and used as Client, poor quality of Internet connection, data transmission is in progress
	Purple	Blinking	Ongoing process of network setup via WPS (starts blinking upon pressing the WPS button)
	White	On	The module is enabled and used as Client, Internet connection is not used, and there is no data transmission
	White	Blinking	The module is enabled and used as Client, Internet connection is not used, but data transmission is in progress
		Off	The module is disabled
	Red	On	The module error (Please contact our Tech Support Department)
Red	Blinking	The module error (Please perform reset to factory settings)	

Icon	Color	State	Description
ZB or IoT (ZigBee Network)	Green	Blinking	Data transmission is in progress, or there are some connected devices
		Off	The module is disabled
	Purple	Blinking	The process of connecting ZigBee devices to the IoT Router is in progress
ZW or IoT (Z-Wave Network)	Green	On	The module is enabled, and there is no data transmission
	Green	Blinking	Data transmission is in progress, or there are some connected devices
		Off	The module is disabled
	Yellow	On	Error during connection of Z-Wave devices to the IoT Router occurred
	Purple	Blinking	The process of connecting Z-Wave devices to the IoT Router is in progress
	Red	On	The module error (Please contact our Tech Support Department)
	Red	Blinking	The module error (Please perform reset to factory settings)
BLE or IoT (Bluetooth)	Green	On	The module is enabled, and there is no data transmission
	Green	Blinking	Data transmission is in progress
		Off	The module is disabled
	Red	On	The module error (Please contact our Tech Support Department)
	Red	Blinking	The module error (Please perform reset to factory settings)
ARM (Armed Mode)	Aqua	On	All devices connected to the IoT Router are armed
	Yellow	On	Not all devices connected to the IoT Router are armed
		Off	The module is disabled
	Red	Blinking	An alarm signal

Icon	Color	State	Description
LTE (3G/4G Connection)	Green	On	The module is enabled, 4G/LTE connection is used, good signal quality, but there is no data transmission
	Green	Blinking	The module is enabled, 4G/LTE connection is used, good signal quality, data transmission is in progress
	Aqua	On	The module is enabled, 3G (UMTS) connection is used, good signal quality, but there is no data transmission
	Aqua	Blinking	The module is enabled, 3G (UMTS) connection is used, good signal quality, data transmission is in progress
	Orange	On	The module is enabled, but there is no data transmission or Internet connection
	Orange	Blinking	The module is enabled, attempt for data transmission, but there is no Internet connection
	Orange	Flickering	SIM Card is blocked, because PIN was not disabled
	Yellow	On	The module is enabled, poor quality of Internet connection, and no data transmission
	Yellow	Blinking	The module is enabled, poor quality of Internet connection, data transmission is in progress
	White	On	The module is enabled, Internet connection is not used, and there is no data transmission
	White	Blinking	The module is enabled, Internet connection is not used, but data transmission is in progress
	Red	On	The module error (Please contact our Tech Support Department)
	Red	Blinking	The module error (Please perform reset to factory settings)
	Off	The module is disabled, no SIM Card or mobile network signal	

Icon	Color	State	Description
 (WAN Connection)	Green	On	The module is enabled, Ethernet Cable is connected, but there is no data transmission
	Green	Blinking	The module is enabled, Ethernet Cable is connected, data transmission is in progress
	Orange	On	Ethernet Cable is inserted into Internet/LAN port, but there is no data transmission or Internet connection
	Orange	Blinking	Ethernet Cable is inserted into Internet/LAN port, there is an attempt for data transmission, but no Internet connection
	Yellow	On	The module is enabled, poor quality of Internet connection, and no data transmission
	Yellow	Blinking	The module is enabled, poor quality of Internet connection, and there is an attempt for data transmission
	White	On	The module is enabled, Internet connection is not used, and there is no data transmission
	White	Blinking	The module is enabled, Internet connection is not used, but there is an attempt for data transmission
	Red	On	The module error (Please contact our Tech Support Department)
	Red	Blinking	The module error (Please perform reset to factory settings)
		Off	Ethernet Cable is not inserted into Internet/LAN port
SH (Connection to Server)	Green	On	Established connection with the remote Smart Home server
	Green	Blinking	data transmission from connected Smart Home device is in progress (Disarmed Mode)
		Off	The device is not activated in the Perenio Smart app
	Red	On	Error connecting to the remote Smart Home server

Icon	Color	State	Description
WPS (Quick setup of wireless network)	Green	Blinking	Quick setup of wireless network is enabled
		Off	Quick setup of wireless network is disabled
Power Button	Green	On	The device is switched on and plugged in to the mains socket, the battery is charged (Battery level: 100%)
	Cyan	On	The device is switched on and plugged in to the mains socket, the battery is charging (Battery level: 76% to 99%)
	Cyan	Blinking	The device is switched on and operates on battery (Battery level: 76% to 99%)
	Cyan	Flickering	The device is switched off and plugged in to the mains socket, the battery is charging (Battery level: 76% to 99%)
	Yellow	On	The device is switched on and plugged in to the mains socket, the battery is charging (Battery level: 51% to 75%)
	Yellow	Blinking	The device is switched on and operates on battery (Battery level: 51% to 75%)
	Yellow	Flickering	The device is switched off and plugged in to the mains socket, the battery is charging (Battery level: 51% to 75%)
	Red	On	The device is switched on and plugged in to the mains socket, the battery is charging (Battery level: 1% to 50%)
	Red	Blinking	The device is switched on and operates on battery (Battery level: 1% to 50%)
	Red	Blinking	The device is switched on and plugged in to the mains socket, but the power capacity of the adapter is exceeded, or an unidentified power adapter is used
Red	Flickering	The device is switched off and plugged in to the mains socket, the battery is charging (Battery level: 1% to 50%)	
Red	Blinking fast	The device is overheated	

Icon	Color	State	Description
		Off	The device is switched off and unplugged from the mains socket

Blinking means that the LED is on for 500 ms, and then is off for 500 ms.

Blinking fast – means that the LED is on for 100 ms, and then is off for 900 ms.

Flickering means that the LED lights up gradually for 800 ms, and then is fading away for 800 ms, and then is off for 1600 ms.

NOTE that certain LED Indicators may be unavailable in your IoT Router configuration, while the other may be united, e.g. "ZB", "ZW" and "BLE" indicators may be united into a single "IoT" indicator.

Table 2 – Push button functionality

Button	Action	Result
Power button	Single press	It is used to switch on the IoT Router
	Press and hold for 2 seconds	It is used to switch off the IoT Router
Reset button	Press and hold for 1 second	It is used to reboot the IoT Router and keep all settings saved (See par. 2.2 below)
	Press and hold for 8 seconds	It is used to reboot the IoT Router and reset all or certain settings (See par. 2.2 below)
WPS button	Press and hold for 1-2 seconds	It is used to start network configuration process

1.2 Identification and Configuration

The IoT Router configuration shall be generated as follows:

PEJIR01_ A A 0 I 2 0 B 0 0 0

ZigBee Module:

0 = Not Available
Z = Available

Bluetooth Module:

0 = Not Available
B = Available

Z-Wave Module:

0 = Not Available
Z = Available

Casing Color:

B = Black
W = White

Built-in Battery:

0 = Not Available
4 = 4,000 mAh
8 = 8,000 mAh

Wi-Fi Class:

2 = AC1200 (MIMO 2x2, up to 866Mbps)
4 = AC2100 (MIMO 4x4, do 1732Mbps)

Wi-Fi Antenna:

I = Internal Wi-Fi Antenna

LTE Module:

0 = Not Available
1 = кат.1 (Download/upload speed of up to 10/5Mbps)
4 = кат.4 (Download/upload speed of up to 150/50Mbps)
6 = кат.6 (Download/upload speed of up to 300/50Mbps)

NAND Flash:

A = FLASH 128MB
B = FLASH 256MB
C = FLASH 512MB

DDR3 RAM:

A = 128MB
B = 256MB
C = 512MB

Article:

PEJIR01 = Elegance Multifunction IoT Router

1.2.1 RAM and Flash Memory

RAM represents the part of the IoT Router memory that affects its performance during certain ongoing processes. RAM stores data to be processed, so the larger its capacity is the less time will be required to complete a particular task or process. Currently, the Elegance IoT Router RAM capacity may be as follows depending on the IoT Router configuration:

- 128 MB;
- 256 MB;
- 512 MB.

As opposed to RAM, flash memory is a non-volatile storage based on a NAND Flash chip that is designed to store data in the device. Information stored in flash memory can be read as many times as you like. Currently, the Elegance IoT Router flash memory capacity may be as follows depending on the IoT Router configuration:

- 128 MB;
- 256 MB;
- 512 MB.

1.2.2 Antennas and the Wi-Fi Class

Antennas in all Elegance IoT Router modules are built-in. However, when operating the device with the LTE module, one external antenna is additionally provided to increase the speed and stability of the mobile Internet signal.

As for the Wi-Fi class, the following configuration options are currently available:

- AC1200;
- AC2100.

AC1200

The total maximum channel speed of access points (867 Mbps for the 5 GHz and 300 Mbps for the 2.4 GHz)

The Wi-Fi Access point supports IEEE 802.11ac

AC2100

The total maximum channel speed of access points (1,300 Mbps for the 5 GHz and 800 Mbps for the 2.4 GHz)

The Wi-Fi Access point supports IEEE 802.11ac

NOTE that the IEEE 802.11ac standard is compatible with previous wireless network standards, i.e. IEEE 802.11a/b/g/n/ac devices can be connected to the access point.

1.2.3 Built-In Battery

Depending on the **Perenio®** IoT Router configuration, it may be equipped with a built-in battery that allows for a 6-hour* autonomous operation of the device in the event of power failures.

The lithium-polymer battery has a higher specific storage density, as well as some other advantages over lithium-ion batteries, namely:

- Higher reliability level since a gel-like polymer composition is used instead of a liquid electrolyte;
- Memory-effect-free battery which provides for the possibility to have a regular smallest charge;
- Insignificant voltage drop during discharge which increases battery performance even if it's not charged for a long period of time;
- Slightly larger capacity.

* The specified time period is the maximum possible duration battery operation when its modules are in a standby mode or disabled. The average duration of device operation from the built-in battery is 3-4 hours.

1.2.4 LTE, Bluetooth, ZigBee and Z-Wave Modules

LTE Module

Currently, the Elegance Multifunctional IoT Router can currently be supplied with an LTE module of one of the following categories:

- Category 1 (LTE Cat 1);
- Category 4 (LTE Cat 4);
- Category 6 (LTE Cat 6).

Table 3 – LTE Category description

Category	Download	Upload	Supported Technology
1	Up to 10 Mbps	Up to 5 Mbps	-
4	Up to 150 Mbps	Up to 50 Mbps	2x2 MIMO
6	Up to 300 Mbps	Up to 50 Mbps	2x2 MIMO, 4x4 MIMO

Bluetooth Module

The IoT Router equipped with the Bluetooth 5.0 Module can receive and transmit data at a distance of up to 100 meters in open areas, as well as of up to 40 meters indoors. At the same time, the module itself is designed to operate within the range of 2,400 MHz to 2,483.5 MHz at a lower power consumption if compared to 802.11b and 802.11g wireless standards.

Bluetooth 5.0 has the following advantages over previous versions:

- An increase in transmission speed from 1 Mbps to 2 Mbps;
- A significant increase in a coverage area;
- An increase in the amount of information transmitted.

ZigBee Module

Availability of the ZigBee module in the IoT Router configuration makes it possible to use it as the Control Gateway to manage sensors and other ZigBee devices within the **Perenio Smart** building management system.

The use of ZigBee allows Users to organize a convenient, safe and energy-efficient environment. The key feature of the ZigBee Protocol is that devices (those which are signal repeaters) do not need to directly contact the IoT Router in order to transmit a signal, since they can transmit it to another device within the network (See Figure below). So, in the case of failure of any node, the network will automatically be restored by establishing new routes for data transfer. This increases both reliability and flexibility of the system making it possible to install sensors at larger distance from the IoT Router even in the presence of obstacles (for example, reinforced concrete walls).

It should also be noted that the ZigBee Protocol has several levels of security and uses the AES-128 encryption algorithm (used by banking and government agencies), which indicates a high level of the transmitted signal protection.

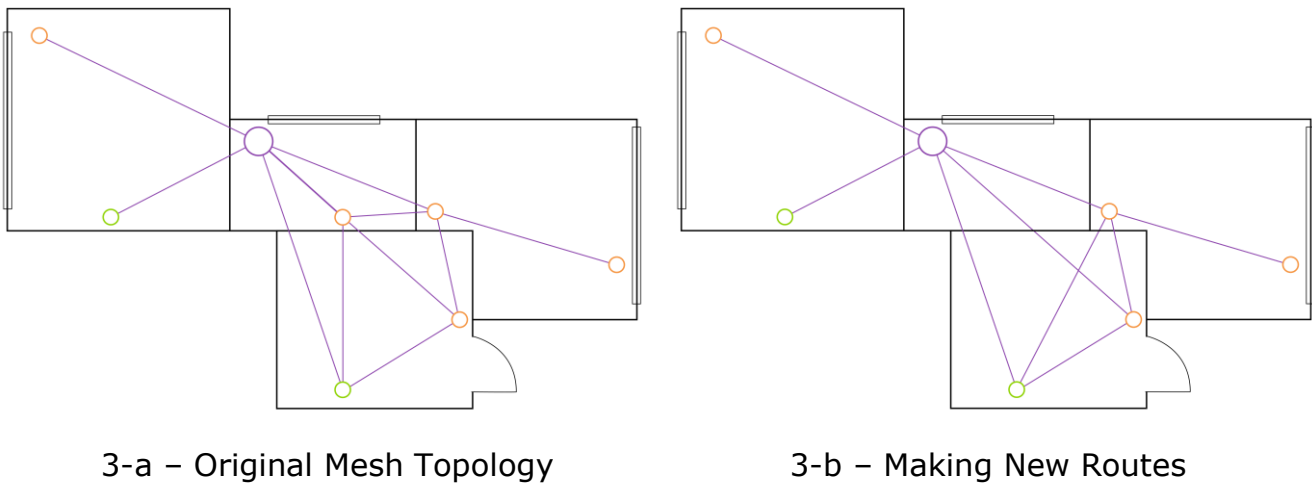


Figure 3 – Self-Recovery of ZigBee Network

Thus, the advantages of using ZigBee 3.0 include the following:

- Data transmission over long distances and protection of transmitted data;
- Ultra-low power consumption and self-recovery of the network;
- Possibility of expanding the network to 65,000 devices and data exchange rate of up to 250 kbps.

NOTE that sensors and other battery-powered **Perenio®** devices do not have a signal repeating function.

Z-Wave Module

Same as ZigBee, Z-Wave technology is based on a mesh network that uses low-energy radio waves for communication.

One of the most important advantages of this technology is security, since Z-Wave is not an open system, so all devices have unique identifiers.

It is also important that Z-Wave devices operate within the range of 800MHz to 900MHz, which means almost no potential sources of interference during operation.

It is worth noting that the Z-Wave Network can support no more than four (4) nodes between devices, and the network itself is limited to 232 devices (instead of 65,000 for ZigBee), but in most cases this amount is enough to fully cover the area.

1.3 Technical Specification

Table 4 – Basic Technical Specifications

Parameter	Value
Article	PEJIR01
Operating System	Linux
Communication Technology*	Wi-Fi (IEEE 802.11b/g/n, IEEE 802.11a/n/ac) ZigBee (IEEE 802.15.4) Ethernet (10/100/1000Mbps RJ-45) Bluetooth (IEEE 802.15.1) Z-Wave LTE, 3G, 2G, UMTS, HSDPA, HSUPA, GPRS, EDGE
Supported Bands**	<p>LTE FDD: B1: 1,920 MHz to 1,980 MHz / 2,110 MHz to 2,170 MHz B3: 1,710 MHz to 1,785 MHz / 1,805 MHz to 1,880 MHz B7: 2,500 MHz to 2,570 MHz / 2,620 MHz to 2,690 MHz B8: 880 MHz to 915 MHz / 925 MHz to 960 MHz B20: 832 MHz to 862 MHz / 791 MHz to 821 MHz B38: 2,570 MHz to 2,620 MHz</p> <p>WCDMA: B1: 1,920 MHz to 1,980 MHz / 2,110 MHz to 2,170 MHz B8: 880 MHz to 915 MHz / 925 MHz to 960 MHz</p> <p>GSM: B3: 1,710 MHz to 1,785 MHz / 1,805 MHz to 1,880 MHz B8: 880 MHz to 915 MHz / 925 MHz to 960 MHz</p>
Power Level**	<p>LTE (B1, B3, B7, B8, B20, B38): 23 dBm ±2.7 dBm WCDMA (B1, B8): 24dBm +1/-3 dBm GSM900 (B3, B8): 33dBm ±2.7 dBm GSM1800 (B3, B8): 30dBm ±2.7 dBm</p>

Parameter	Value
	Wi-Fi (2.4GHz): 18 dBm Wi-Fi (5GHz): 15 dBm ZigBee: 19 dBm Z-Wave: 13 dBm (Continuous wave mode)
Wi-Fi Security Mode	WPA/WPA2 – personal WPA/WPA2 – enterprise
Supported Protocol	TCP/IP, HTTP, MQTT
User Interface Compatibility	Windows, MacOS, Linux, Ubuntu, iOS (12.1 and higher) and Android (5.0 and higher, for Google Mobile Services supported devices)
RAM	128 MB / 256 MB / 512 MB
Flash Memory	NAND Flash: 128 MB /256 MB / 512 MB
Ports	1x WAN (10/100/1000 Mbps) 2x LAN (10/100/1000 Mbps)
USB Ports	USB 2.0 (USB modem supported, 480Mbps max) USB 3.0 (USB modem supported, 4.8Gbps max)
Antenna Ports*	1x SMA (For external LTE Antenna only)
Wi-Fi Module (2.4GHz)	Operating frequency: 2,400 MHz to 2,483.5 MHz Coverage area: Up to 100 m (open area) Type: Built-in Max RF Output Power: 20 dBm Receiver Sensitivity: -85 dBm Antenna Gain: 3 dBi
Wi-Fi Module (5GHz)	Operating frequency: 5,150 MHz to 5,875 MHz Coverage area: Up to 100 m (open area) Type: Built-in Max RF Output Power: 18 dBm Receiver Sensitivity: -91 dBm Antenna Gain: 3 dBi
ZigBee Module	Operating frequency: 2,400 MHz to 2,483.5 MHz Coverage area: Up to 100 m (open area)

Parameter	Value
	Repeater: Yes Connected devices: Up to 150 devices Type: Built-in Max RF Output Power: 20 dBm Antenna Gain: 4 dBi
Z-Wave Module	Operating frequency: 868.42 MHz Sub-GHz frequency: 865.2 MHz to 926.3 MHz Coverage area: Up to 100 m (open area) Type: Built-in Max RF Output Power: 18 dBm Antenna Gain: 3 dBi
Bluetooth Module	Coverage area: Up to 100 m (open area) Type: Built-in
LTE Module	Operating frequency: 900 MHz/1,800 MHz (GSM); 800 MHz/2,100 MHz (WCDMA); 1,800 MHz/ 2,100 MHz/2,600 MHz/900 MHz/800 MHz (FDD) Type: Built-in/External* Max RF Output Power: 33 dBm Antenna Gain (built-in): 3 dBi Antenna Gain (external): 4 dBi SIM Card support: 1x 4FF (nano-SIM)
Server	Cloud
Buzzer*	Type: Built-in Sound level: Up to 95 dB/3 m
Power	Input: 12 VDC/2.08 A Power Consumption: 24.96 W max Power adapter: 100-240 VAC, 50/60 Hz, 0.6 A
Battery*	Type: Li-polymer, built-in Voltage: 3.6 V Capacity: 4,000 mAh/8,000 mAh Discharge time: Up to 6 hours (See par.1.2.3)
Operating Temperature	0 °C to +40 °C

Parameter	Value
Operating Humidity	10% to 85% RH, non-condensing (For devices with built-in battery: 35% to 85% RH, non-condensing)
Storage Temperature	-10°C to +70°C (For devices with built-in battery: -10°C to +25°C)
Storage Humidity	10% to 85% RH, non-condensing (For devices with built-in battery: 35% to 85% RH, non-condensing)
Casing Protection Class	IP30
RTC Module	Built-in
Installation	On a horizontal or vertical surface (See par.2.1.5)
Casing Material	Body: ABS+PC (matte) Front panel: anodized aluminum
Color	White/Black
Dimensions (L x W x H)	142 x 142 x 35 mm
Weight	430 g (875 g with accessories)
Warranty Period	2 years
Service Life	5 years
Certification	CE, EAC, RoHS, UA.TR, UN38.3, TP.BY
Data Protection	GDPR Compliance

* Some components, modules, and/or functions may not be available in your IoT Router configuration. See paragraph 1.2.

** Maximum signal transmission power depends on the channel and local regulations. Available channels comply with local regulations.

1.4 Scope of Delivery

The following items and accessories are supplied within the IoT Router package:

1. PEJIR01 Multifunction IoT Router – 1 pc.
2. External LTE Antenna* – 1 pc.
3. Ethernet Cable (1.5 m) – 1 pc.)
4. USB-C Power Adapter (1.5 m) – 1 pc.
5. Screws and dowels – 1 set.
6. SIM Card tray staple – 1 pc.
7. Quick Start Guide – 1 pc.
8. Warranty Card – 1 pc.

9. Informational Sticker – 1 pc.

10. Perenio sticker – 1 pc.



Figure 4 – Scope of Supply**

* The external antenna is supplied for configurations with the LTE Module.

** Images of accessories are provided for informational purposes only.

1.5 Packaging and Labelling

The **Perenio[®]** IoT Router is supplied in a carton Gift Box of 170 x 170 x 85 mm (L x W x H) containing the full name and marking of the device, the list of accessories provided and basic technical specifications thereof, as well as the date of manufacture and information about the manufacturing plant of devices.

1.6 Safe Operation Rules

For the proper and safe operation of **Perenio[®]** IoT Routers, follow the instructions and safety procedures described in the present Manual. The Manufacturer shall not be liable for any damage caused as a result of improper operation of devices.

1. Do not install the device outdoors or use it in area with high humidity/dust content, because it may result in serious damage of the device.
2. Do not install the device next to sources of increased heat such as heaters, radiators, stoves, ovens, etc., as well as electronic devices that generate strong magnetic or electric fields (microwave, refrigerator, etc.).
3. Do not allow water or foreign objects to contact with internal parts of the device.
4. Users shall observe storage/transportation conditions, as well as the operating temperature mode of the device as declared by the Manufacturer.
5. Do not block ventilation holes, i.e. do not operate the device if it's inside the box or covered.

6. Do not drop, throw or bend the device. Do not disassemble or attempt to repair the device on your own.
7. In order to avoid personal injury, do not use the device, if it's cracked or in any other way damaged, or in the presence of any signs of smoke or an unusual smell, or if the device makes any unusual noises.
8. Do not bend or break cables supplied with the device, as this may adversely affect operation of the latter.
9. To extend the device life, it is recommended to disconnect it from the mains, as well as disconnect all cables, if you are not using it for a long time.
10. Do not install device firmware other than that provided by the Manufacturer.
11. Follow the built-in battery operating rules.
12. When using the USB 2.0 and USB 3.0 Ports, do not disconnect the device from the mains (i.e. the device must not be switched to battery operation).
13. Prevent short circuits and depressurization of the battery (if any).
14. Charge the battery (if any) on a regular basis.
15. Use only the original battery model only (if any).
16. Use only the original power adapter for charging.
17. Do not connect third-party portable chargers to the port intended to be used for the power adapter.
18. Use dry cloth or cloth soaked in a small amount of water for cleaning (don't use harsh chemicals/cleaning agents). The device must be powered off before cleaning.
19. Children shall not be allowed to use the device unsupervised and/or play with it.

2 Installation and Setup

The entire setting-up process can be divided into several key steps as follows:

- Connection of the IoT Router to the source of power, and cabling;
- Making settings in the admin panel;
- Connection of smart home devices to the IoT Router through the **Perenio Smart** mobile app*;
- Installation of the device in the selected area.

NOTE that the *Perenio Smart Home & Office Mobile App Manual* document is available for downloading at the web-site.

** connection of ZigBee/Z-Wave devices is possible, if corresponding modules are available in the IoT Router configuration.*

2.1 Initial Installation and Configuration

2.1.1 Switching on and Booting Up

In order to correctly install and operate the IoT Router, the User shall follow the steps below:

1. Unpack the IoT Router and connect it to the mains using the power adapter (See Figure 10 below). Wait for at least 30 minutes for the device to be recharged.
2. Switch on the device by single pressing the power button until its LED indicators flash bright white.
3. The power button will flash one of operating colors (See below).

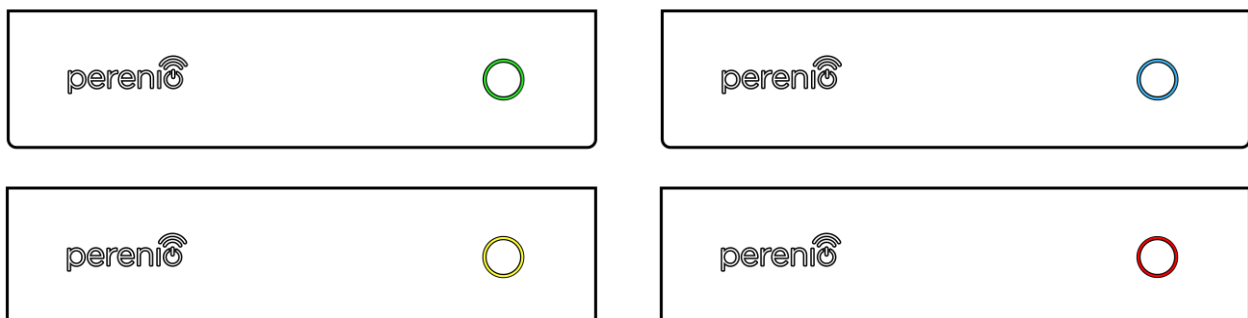
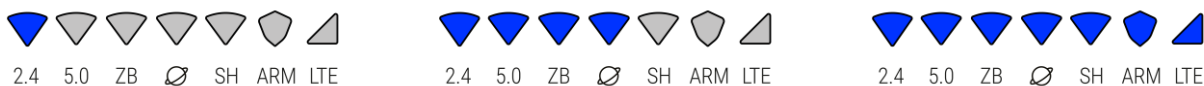


Figure 5 – Available colors of the power button after switching on the device

NOTE that after being switched on, the color of the power button indicator will depend on the battery charge level (See Table 1 – LED Indicator Statuses).

4. The IoT Router booting up process will be started as follows:

- a. LED indicators will blink blue on the device casing;
- b. Sequential loading of device modules will be started;



6-a – Successful loading of the first module 6-b – Successful loading of the first four modules 6-c – Successful loading of all modules

Figure 6 – The process of loading device modules

- c. After all modules are successfully loaded, the device will switch to an operating mode, while indicators will start flash/blinking according to Table 1 – LED Indicator Statuses.

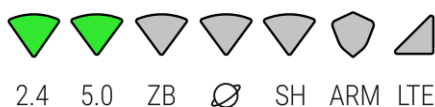


Figure 7 – Device operating mode indication option

2.1.2 Initial Setting-Up

1. Go to the list of available wireless networks on the device that will be used for the initial setting-up of the IoT Router (PC, laptop, smartphone, etc.) and make sure that two Perenio access points are available in the list (e.g., Perenio-2.4G-IK9R and Perenio-5G-IK9R).

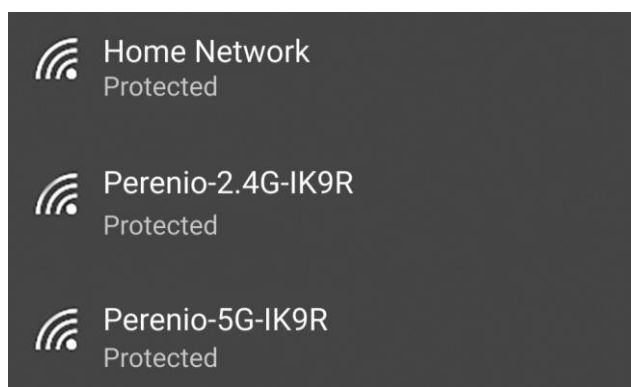


Figure 8 – Example of the list of available Wi-Fi networks

2. Connect the device (PC, laptop, smartphone, etc.) to one of the above access points of the IoT Router.

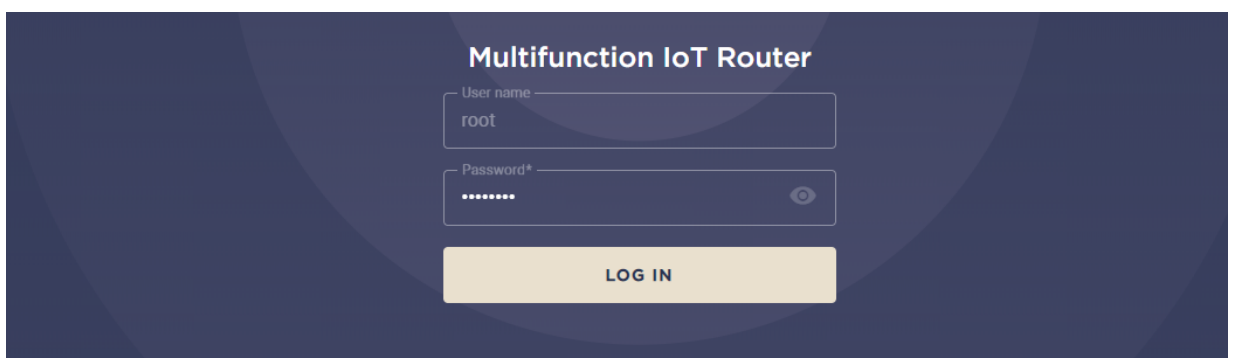
NOTE that if the User has a PC or a laptop with an RJ-45 connector to set up the IoT Router, such a device can also be connected via an Ethernet cable, so that one end of the cable shall be inserted into the RJ-45 port of the PC/laptop, while the other one – into the LAN1 or LAN2 port on the Elegance Multifunction IoT Router casing. **In this case, steps 1 and 2 should be skipped.**

3. On the device selected for setting-up, open any web browser and in the address bar, enter the IoT Router URL or the IP address specified on the information sticker at the bottom of the device casing, or in the quick start guide (See Figure below). Then, click on the “ENTER” button.

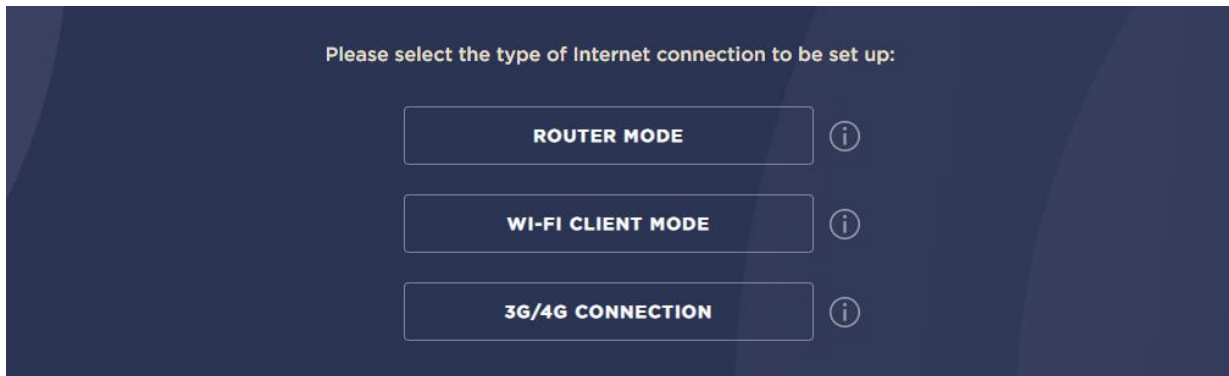


Figure 9 – Example of the device information sticker

4. Enter the username and the password specified on the information sticker at the bottom of the device casing, or in the quick start guide (See Figure above), and click on the “LOG IN” button.



5. The IoT Router Quick Setup window shall be displayed.
6. Select one of the Internet connection methods as follows:



NOTE that to ensure stable access to the Internet, it is recommended to select the same name and password for all created connection types (Router and Wi-Fi Client modes, 3G/4G Connection).

I. Router Mode

If selected, the User shall first connect the IoT Router to the Internet outlet of the Internet Service Provider (ISP) by plugging one end of the Ethernet cable into this Internet outlet and the other one – into the Internet/LAN Port on the IoT Router (See Figure below).

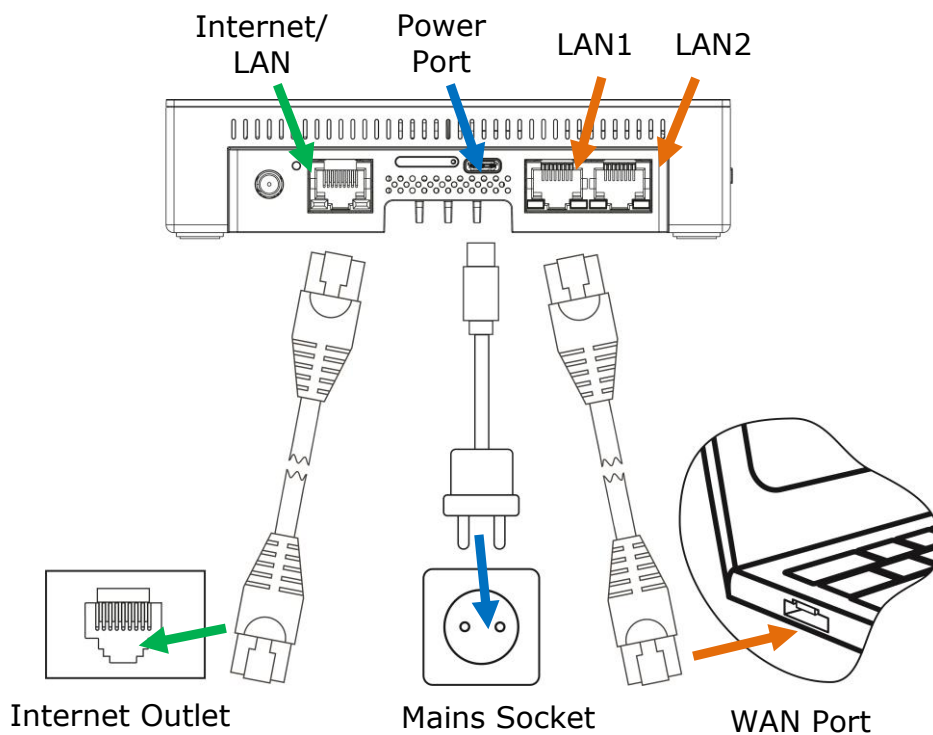


Figure 10 – Connection to the Internet outlet, mains socket and the laptop

Select one of the most relevant types of connection as follows:

- **Dynamic IP** (DHCP Client) that is used when the ISP assigns dynamic IP addresses (This method is the most commonly used since settings are generated automatically);



The screenshot displays the 'Dynamic IP Settings' interface. It features a title 'Dynamic IP Settings' and a subtitle 'Generated settings:'. Below this, there is a table of settings:

IP Address:	192.129.31.171
Primary DNS:	192.168.31.1
Secondary DNS:	192.168.1.4
Default Gateway:	192.168.31.1

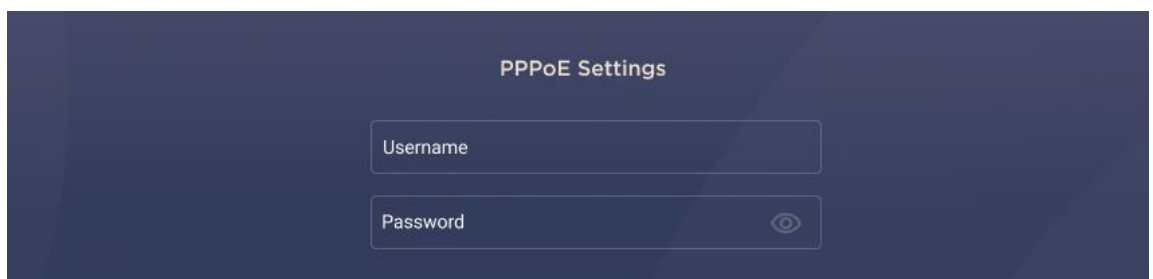
- **Static IP** that is used when the ISP assigns static (permanent) IP addresses;



The screenshot displays the 'Static IP Settings' interface. It features a title 'Static IP Settings' and several input fields for configuration:

- IP Address
- Subnet Mask
- Default Gateway
- Primary DNS
- Secondary DNS

- **PPPoE** that is typically used for ADSL/VDSL connection (The ISP will provide login and password for authorization);



The screenshot displays the 'PPPoE Settings' interface. It features a title 'PPPoE Settings' and two input fields:

- Username
- Password (with a toggle icon for visibility)

- **PPTP** that may be used for an unsecured connection between two local networks;
- **L2TP** that may be used when connecting via VPN (VPN server IP address or domain name must be known).



L2TP Settings

Username

Password

IP Address

Subnet Mask

Default Gateway

VPN Server

Primary DNS Secondary DNS



PPTP Settings

Username

Password

IP Address

Subnet Mask

Default Gateway

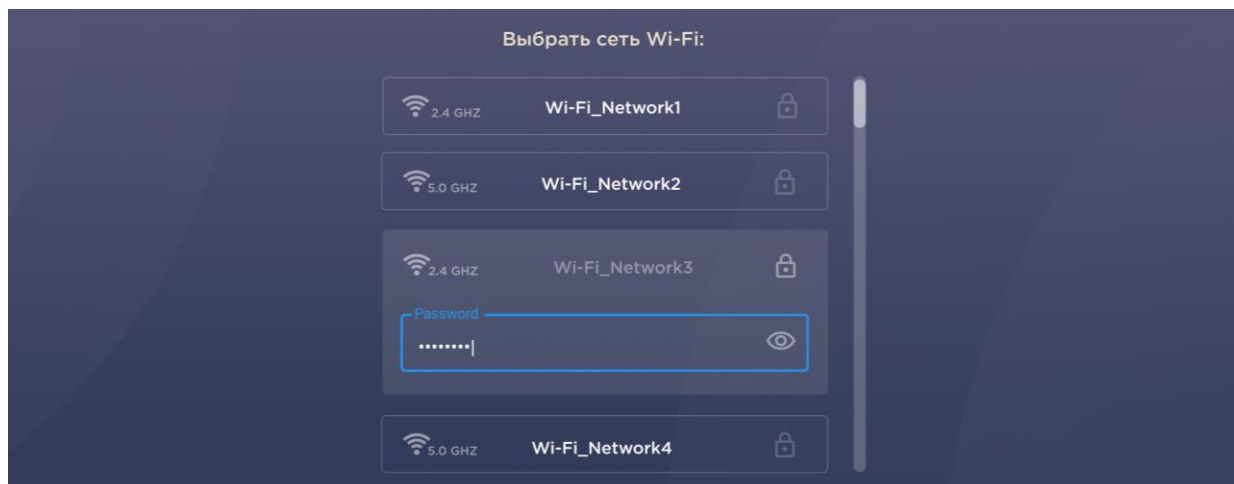
VPN Server

Primary DNS Secondary DNS

NOTE that your ISP guides shall be followed to set up a connection.

II. Wi-Fi Client (Wireless Client)

This method allows a User to connect the IoT Router to an existing Wi-Fi Network. The User shall know this network name and password.



Выбрать сеть Wi-Fi:

- 2.4 GHZ Wi-Fi_Network1 [lock icon]
- 5.0 GHZ Wi-Fi_Network2 [lock icon]
- 2.4 GHZ Wi-Fi_Network3 [lock icon]
- 5.0 GHZ Wi-Fi_Network4 [lock icon]

Password

.....| [eye icon]

After being connected to the Wi-Fi network, the User shall enter the desired access point name and password (WPA-PSK Key).

WIFI Access Point

5 GHz

Network Name (SSID) *
PEJIR01_Home_AP

WPA Encryption
WPA-PSK 2

Authentication Method
AUTO

WPA-PSK key *
.....
At least 8 characters

III. 3G/4G Connection

This connection method can be used, if an LTE module is available in your IoT Router configuration, and **the external LTE Antenna is screwed on**, as well as when the User has a valid nano-SIM Card.

To set up the connection, the User shall screw on the external antenna, insert the nano-SIM into the SIM Card slot at the back of the IoT Router casing (See section 2.1.6 below), and wait for the SIM Card to be detected by the device.

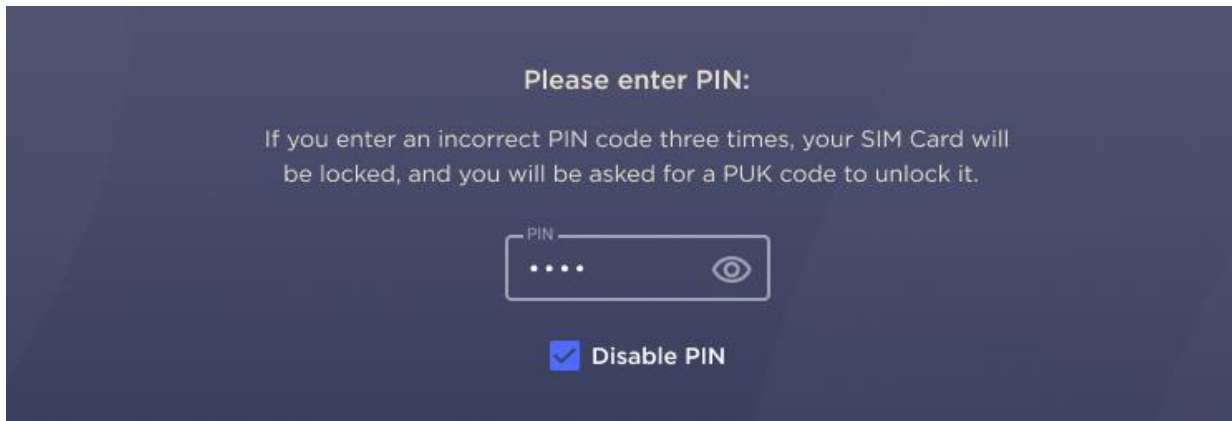
ATTENTION! Do not insert or remove the SIM Card, if the IoT Router is switched on, as this may adversely affect its operation, and also may damage the card itself.

ATTENTION! Do not use the LTE Connection without external antenna!

If the SIM Card was not automatically detected by the IoT Router, the User shall restart the device by clicking on a corresponding (RESTART) button in the admin panel, and select the 3G/4G Connection method once again.

After successful detection of the SIM Card, the PIN code entry window will appear, and the LTE module indicator will flash green.

At this step, it is recommended to disable the PIN code check, otherwise every time the IoT Router restart or reset during operation, the User will have to re-enter the PIN code to unblock access to the SIM Card, and the LTE connection, accordingly.



NOTE that in the case that the PIN code is entered incorrectly three times in a row, the SIM card will be blocked, and the User will be redirected to the PUK code entry screen to unblock it.

To complete the 3G/4G Connection, the User shall enter the access point name (APN) provided by your provider, as well as login and password.

NOTE that the APN value for most mobile operators is "Internet". Some of operators will also ask for login and password (Such data will be specified in the starter package). If such data is not indicated, the User shall leave fields empty and click on the "Next" button, or contact their mobile operator to clarify the information.

The User may also check the SIM card balance and read information received from the mobile operator.

7. After setting up the Internet connection, the User shall proceed to setting up Wi-Fi access points by selecting one of the following options:
 - a. Create two single-band Wi-Fi access points (one of 2.4GHz and another one of 5GHz);
 - b. Create one dual-band Wi-Fi access point (a shared 2.4 GHz and 5 GHz hotspot will be created).
8. Enter the access point name (SSID), and select encryption type and password (WPA-PSK Key).

NOTE that for the Wi-Fi Client Mode, only one access point will be available for Wi-Fi distribution by this IoT Router.

The screenshot displays the 'Dual Band Wi-Fi Access Point' configuration interface. At the top, there is a toggle switch for 'Dual Band Wi-Fi Access Point' which is currently turned on. Below this, a note states: 'If enabled, both 2.4GHz and 5GHz bands will be united in a single Wi-Fi Access Point'. The interface is divided into two columns: '2,4 GHz' and '5 GHz'. Each column contains four input fields: 'Access Point Name', 'Authentication Method', 'WPA Encryption', and 'Password'. For the 2.4 GHz band, the values are: PEJIR01_Home_2.4, WPA2-Personal, AES, and a masked password. For the 5 GHz band, the values are: PEJIR01_Home_5, WPA2-Personal, AES, and a masked password. Each password field has an eye icon to toggle visibility.

2.1.3 First Firmware Update

After initial setup of Internet connection and prior to performance of any IoT settings (i.e. before the initial activation of the IoT Router to the Perenio Smart application), the User shall first update the IoT Router firmware to the current version. To do this, the User shall restart the device by clicking on the reset button (See method 1 in par.2.2 below), or by clicking on the "Reboot" button in the right upper corner of the admin panel (See Figure in par.2.2 below). The process of updating will be started within a few minutes after rebooting.

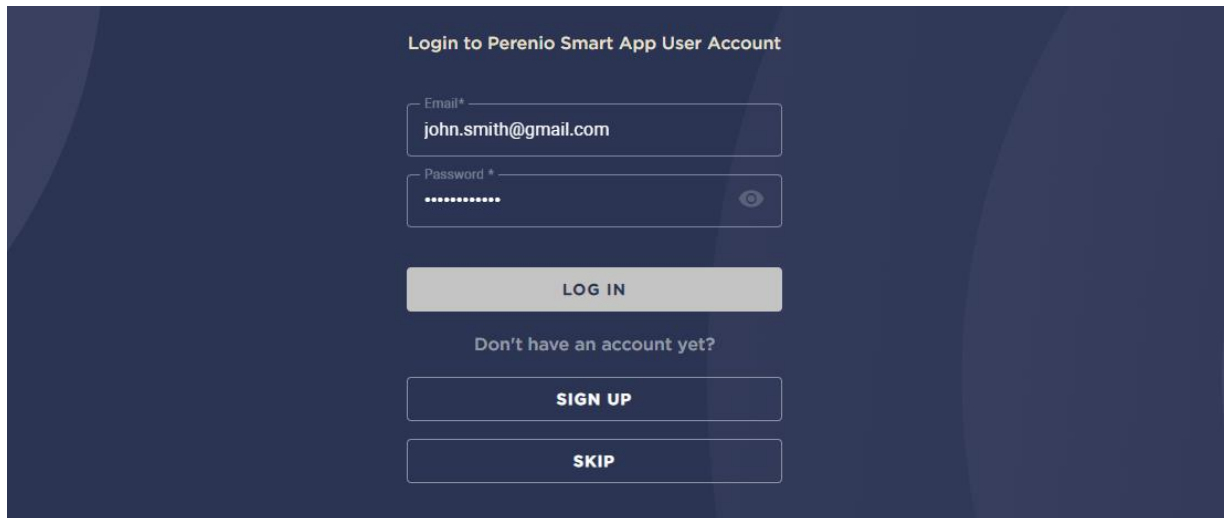
ATTENTION! Due to a sequential firmware update process, the total number of reboots of the IoT Router can reach six (6) times and more. The firmware update is considered completed when the IoT Router stops rebooting, and its LEDs start flashing/blinking according to Table 1 – LED Indicator Statuses (Also, see Figure 7 above).

2.1.4 Activation in the Perenio Smart App

At this stage, the User can activate the IoT Router in the **Perenio Smart** mobile application in order to additionally manage it as a Control Gateway for smart devices. The User may also skip this step and activate the IoT Router later in the admin panel or the mobile app.

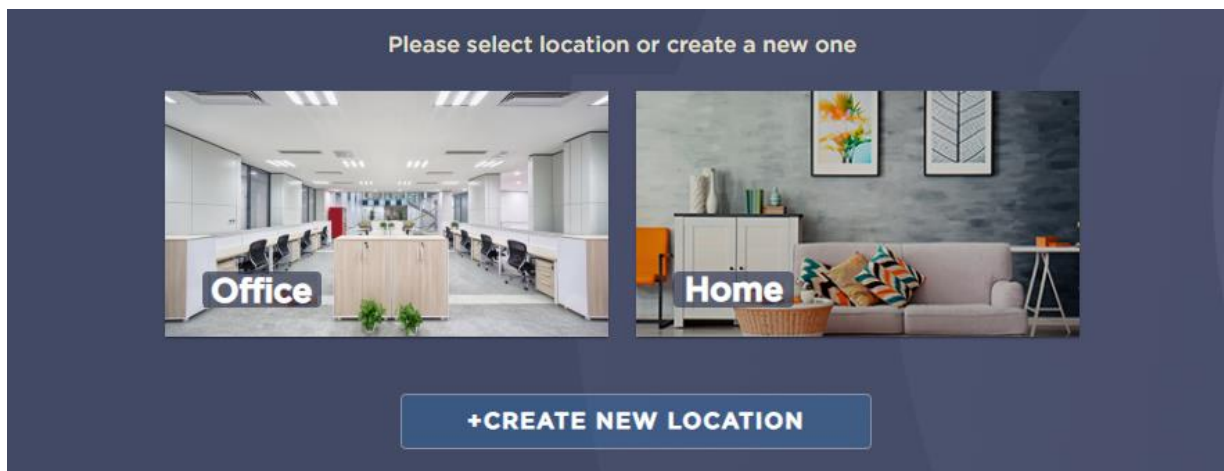
To complete IoT settings, please perform the following steps:

1. Log in to the User Account of the **Perenio Smart** application via the admin panel, or create a new account.

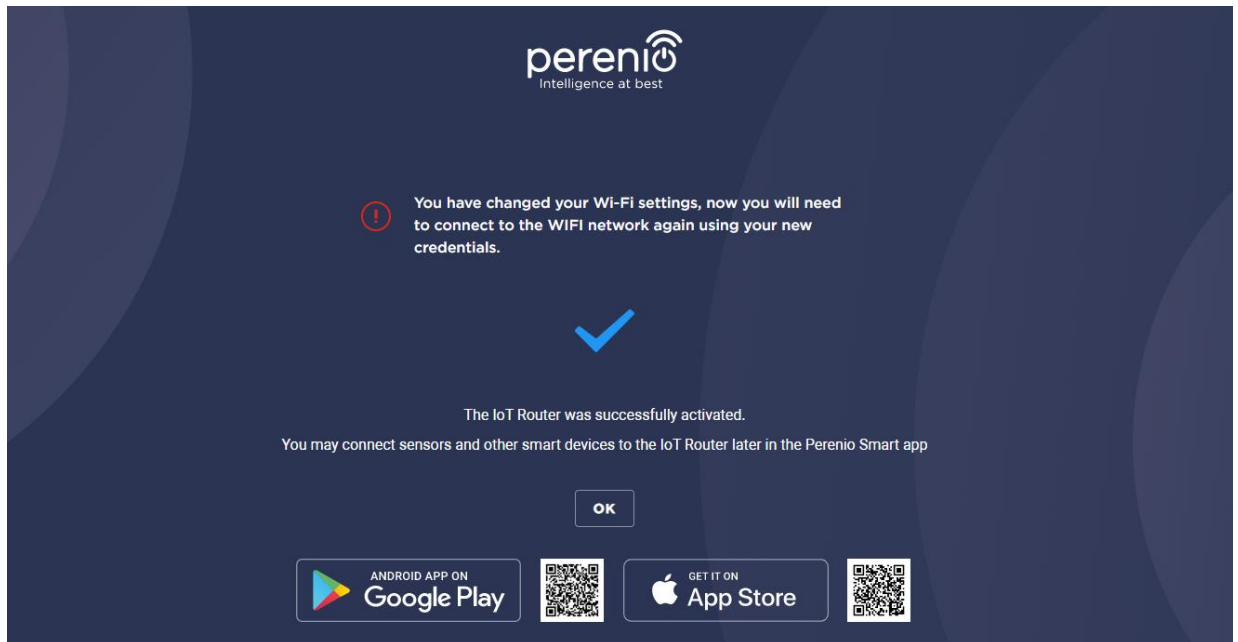


NOTE that a new User may register an account from the admin panel, the **Perenio Smart** application or **perenio.com**. The account password must be 8 or more symbols including at least one uppercase letter, one lowercase letter and one number. It is allowed to use **!@#%^&*._** symbols.

2. Select Location to install the IoT Router, or create a new one.



3. Complete the activation process by clicking on the "DONE" button.



4. Log in to your User Account via the **Perenio Smart** mobile application and make sure that the IoT Router is in the list in the "Devices" tab.

NOTE that after that, sensors and other smart devices may be connected to the IoT Router in the **Perenio Smart** mobile application.

The device can be configured as a Wi-Fi router only from the admin panel, while its activation as a Control Gateway for "smart" devices can be performed from both the admin panel and the **Perenio Smart** mobile application.

2.1.5 Area Selection and Installation

Before installation, the User shall select one of possible IoT Router locations on a horizontal or vertical surface, as well as make sure that the selected location meets the following requirements:

- Availability of a mains socket near the installation site of the IoT Router;
- Flat and stable surface in the installation site of the IoT Router.

NOTE that it is not recommended to install the device in areas with a high level of noise and a high-frequency interference. Reinforced concrete floors may reduce distance of wireless signal transmission.

Below see possible locations for the IoT Router.



Figure 11 - Examples of installation*

** Images are provided for informational purposes only*

If the device shall be mounted using screws, the distance between mounting holes must be taken into account when drilling the holes (The distance is 10 cm).

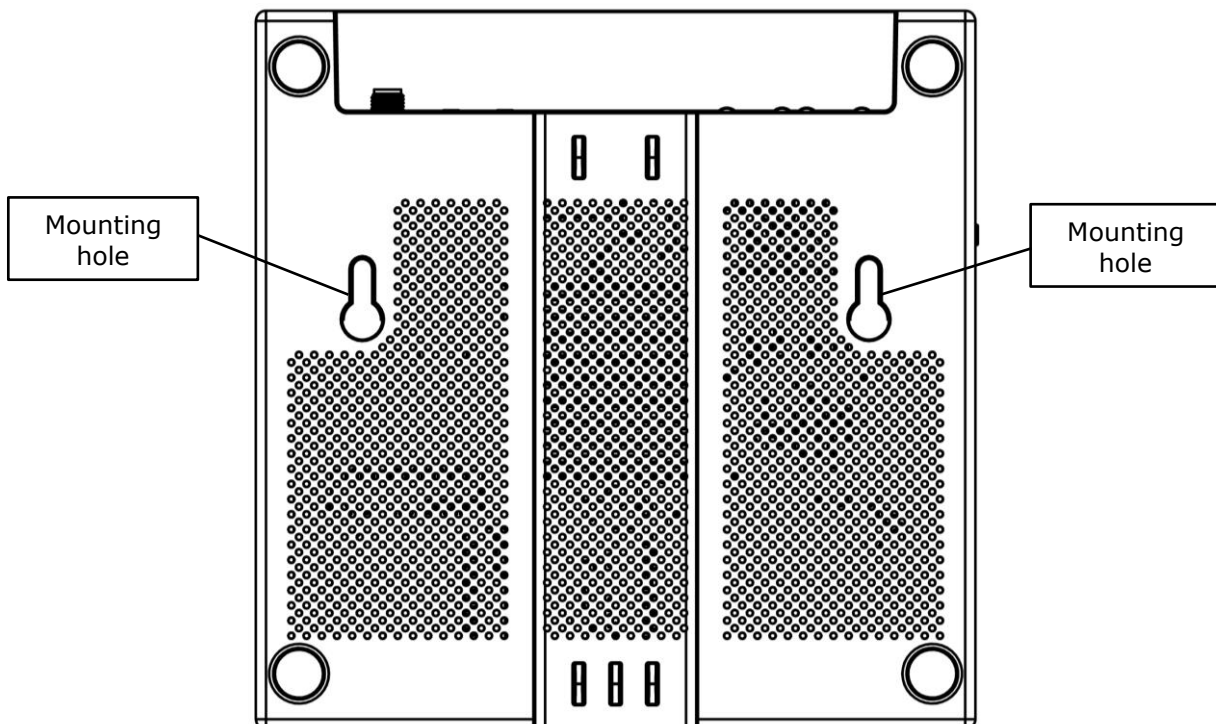


Figure 12 – Mounting holes

2.1.6 External Antenna Assembling

It is possible to use one external antenna for the Elegance IoT Router equipped with the LTE Module in order to enhance the LTE signal.

To install the antenna, the User shall follow steps below:

1. Turn off the device and disconnect it from the mains.
2. Insert the external LTE antenna supplied with the device into the SMA port on the device casing (See Figure below).
3. Tighten the antenna by rotating it clockwise.

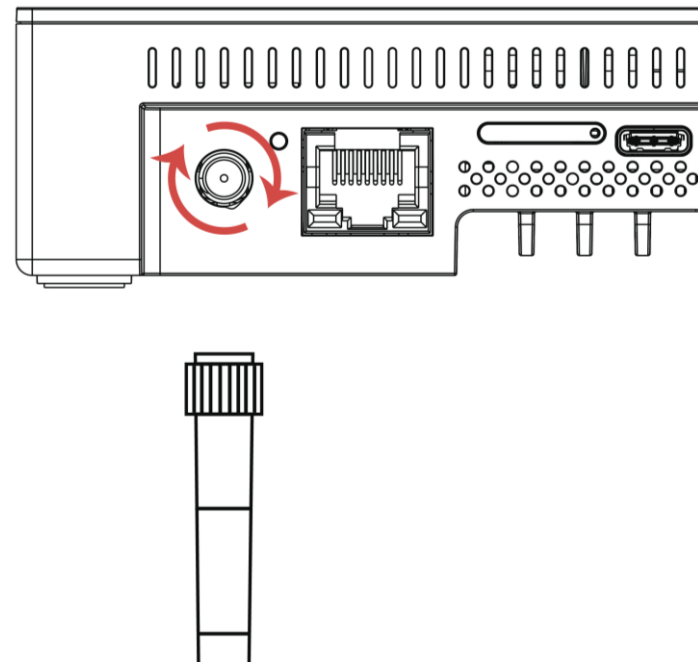


Figure 13 – Tightening the external antenna

ATTENTION! Both the external antenna and the IoT Router are for indoor use only.
ATTENTION! Do not use the LTE Connection without external antenna!

2.1.7 Inserting Nano-SIM Card

The SIM Card shall be inserted into a special holder located at the back of the IoT Router casing (See figure below).

The installation process shall be performed as follows:

- **Turn off** the IoT Router by pressing and holding the power button for **2 seconds** until the LED Indicators turn bright white;
- Using a staple supplied with the device, remove the SIM Card holder from the IoT Router casing carefully;

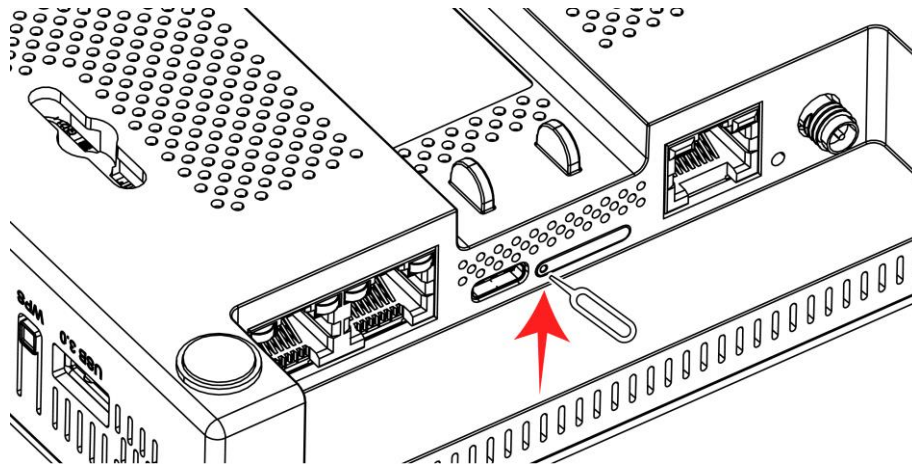


Figure 14 – Removing the SIM Card holder from the casing

- Insert the SIM Card into the holder with due regard to its orientation (Beveled corners shall be aligned);

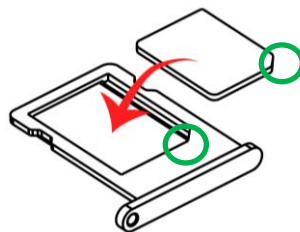


Figure 15 – Inserting the nano-SIM into the holder

- Insert the holder with the SIM Card back into the IoT Router casing;
- Turn on the IoT Router by single pressing the power button;
- Reboot the device using the reset button (See description in par. 2.2 below), or in the admin panel by clicking the "REBOOT" button in the right upper corner of the screen.



IMPORTANT! A SIM Card tray staple supplied with the device shall be used to press the reset button located on the back of the IoT Router casing.

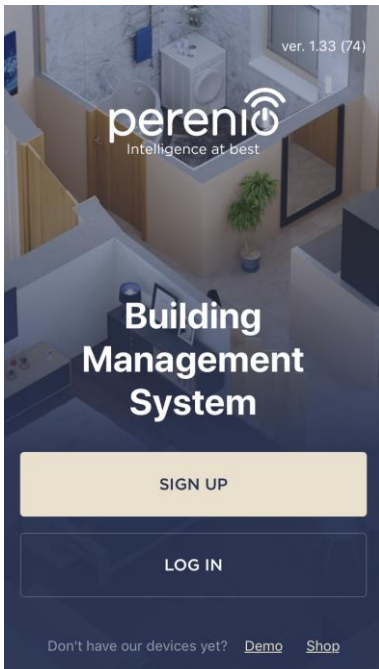
2.1.8 Activation of the IoT Router in the Perenio Smart App

The Elegance Multifunction IoT Router can be activated in the **Perenio Smart** mobile app in the same way as any **Perenio[®]** Control Gateway. Activation shall be performed the following steps:

1. Install the **Perenio Smart Home & Office** mobile application on your smartphone and log in to the User Account (See par. **A** below).
2. Scan the QR Code, or enter CG data manually (See par. **B** below).
3. Enter your Wi-Fi Network data (See par. **C**).
4. Enter the desired name and select Location (See par. **D** below).

ATTENTION! The Device must not be switched off or disconnected from the mains for at least **5 minutes** after the RESET Button is pressed, as well as for at least **10 minutes** after the firmware update process is started, if the device is not equipped with a built-in battery, or if the battery is discharged.

A. INSTALLATION OF THE PERENIO SMART MOBILE APP



In order to log in to the User Account, follow the steps below:

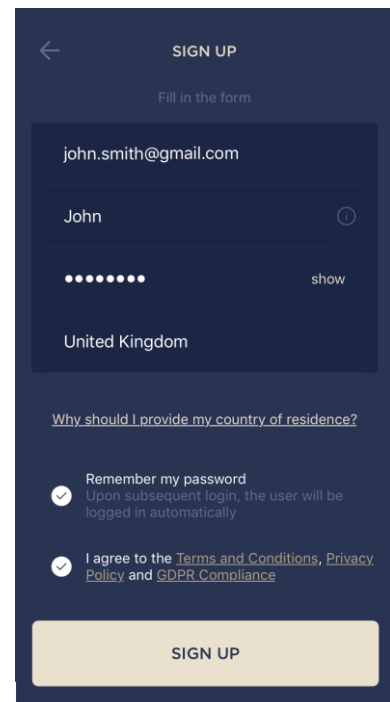
- a.** Connect your smartphone to the Wi-Fi Network and download the **Perenio Smart Home & Office** app from Google Play or App Store;
- b.** Register a new User Account (See par. **A.1.** below) or sign in to an existing User Account (See par. **A.2.** below).

A.1. NEW USER ACCOUNT REGISTRATION

- a. Fill in your e-mail address, user name and password then select the country of residence;

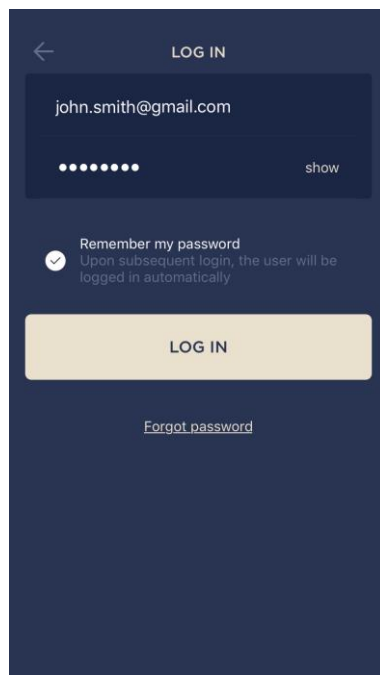
NOTE that the account password must be 8 or more symbols including at least one uppercase letter, one lowercase letter and one number. It is allowed to use **!@#%^&*._** symbols.

- b. Agree to General Terms and Conditions, Privacy Policy and provisions for personal data protection (accessible by the link);
- c. Click on the **SIGN UP** Button.
The User will receive an email to verify the User Account (Follow the link);
- d. Log in to the User Account.



The screenshot shows a mobile application interface for signing up. At the top, there is a back arrow and the title 'SIGN UP'. Below the title, it says 'Fill in the form'. The form contains several input fields: an email address field with 'john.smith@gmail.com', a name field with 'John', a password field with seven dots and a 'show' link, and a country selection field with 'United Kingdom'. Below these fields, there is a link that says 'Why should I provide my country of residence?'. There are two checkboxes: 'Remember my password' (checked) with the subtext 'Upon subsequent login, the user will be logged in automatically', and 'I agree to the Terms and Conditions, Privacy Policy and GDPR Compliance' (checked). At the bottom of the form is a large yellow button labeled 'SIGN UP'.

A.2. LOGGING IN TO THE EXISTING USER ACCOUNT



The screenshot shows a mobile application interface for logging in. At the top, there is a back arrow and the title 'LOG IN'. Below the title, there are two input fields: an email address field with 'john.smith@gmail.com' and a password field with seven dots and a 'show' link. Below these fields, there is a checked checkbox for 'Remember my password' with the subtext 'Upon subsequent login, the user will be logged in automatically'. At the bottom of the form is a large yellow button labeled 'LOG IN'. Below the button is a link that says 'Forgot password'.

- a. Enter your e-mail address and password in the login screen.
- b. Click on the **LOG IN** button.

NOTE. If the password is lost, the User can restore it by clicking on a corresponding link on the screen.

To restore a forgotten password, use the e-mail address linked to your User Account, as instructions on changing the password will be sent thereto.

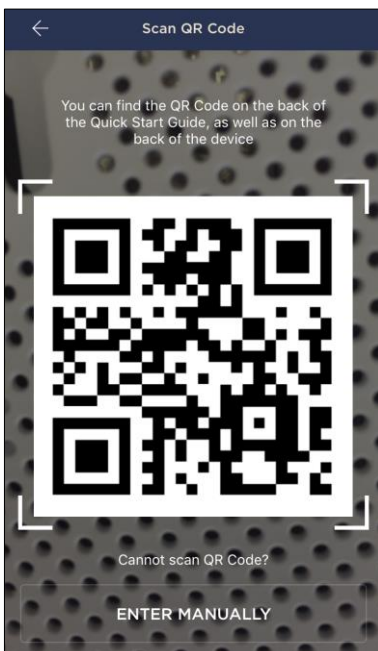
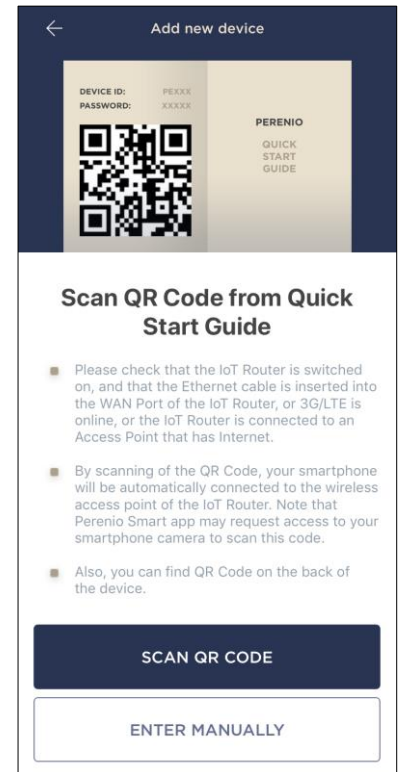
B. DEVICE ACTIVATION BY QR CODE SCANNING

a. Switch to the QR Scan screen as follows:

- **For new Users:** The QR Scan screen will be displayed immediately after the first login to the Perenio Smart App User Account;
- **For existing Users:** After login to the Perenio Smart App User Account, click on the "+" icon in the upper right corner of the "Devices" tab, select "Add new device" and then the "IoT Router" device in the list.

b. Click on the **SCAN QR CODE** button;

c. Confirm permission to access your smartphone camera in the pop-up window (It may not be available for certain smartphone models);



d. Find the QR Code sticker on the back of the Quick Start Guide supplied with the device or on its bottom and place your smartphone 15-20 cm away from it, so that the QR Code is completely visible on the smartphone screen (See the picture on the left).

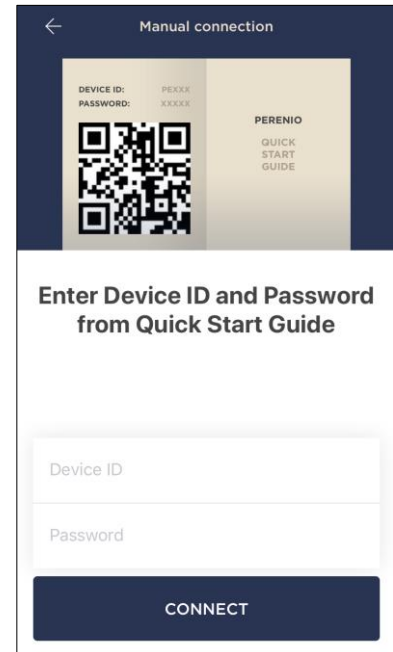
NOTE. In the event that the QR Code can't be scanned, you may activate the device manually (see par. **B.1.** below).

e. Allow the **Perenio Smart** app to access the location of your smartphone, so that the W-Fi network can be detected and connected to.

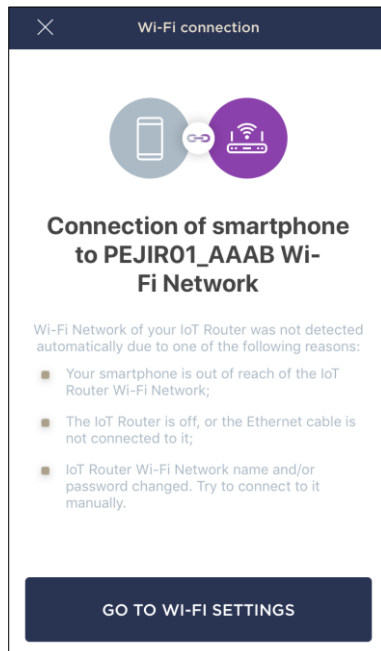
B.1. MANUAL ACTIVATION OF THE DEVICE

If the QR Code was damaged or lost, you can enter the device data manually as follows:

- a. Click on the **ENTER MANUALLY** button at the bottom of the QR Code scan screen (See the figure in par. **B**);
- b. Enter the Device ID and the Password specified in the Quick Start Guide or on the bottom of the device (ID and Password lines next to the QR Code);
- c. Click on the **CONNECT** button.



C. CONNECTING TO WI-FI NETWORK



After scanning the QR Code, the device activation process will start. It consists of the following three steps:

- Step 1: Initialization;
- Step 2: Applying of settings;
- Step 3: Activation.

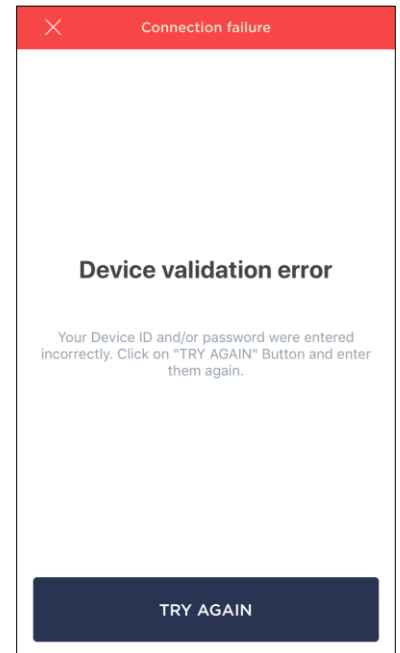
NOTE that if the User has changed the name and/or password for the device access point (i.e. SSID and password indicated on the information sticker at the bottom of the device) during the IoT Router configuration, a corresponding screen will be displayed (See on the left) after completion of Step 1. In this case, the User should click on the "Go to Wi-Fi Settings" button, find the renamed access point in the list and connect to it manually. After that, the User shall go back to the application and continue the connection process.

C.1. CONNECTION ERRORS

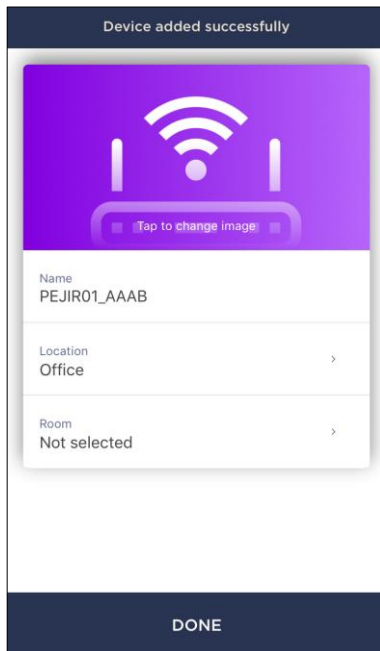
The connection failure of the device may occur due to one of the following reasons:

- a.** The device is switched off or at a too long distance from the smartphone;
- b.** The device was already activated in the current or some other User Account;
- c.** The device ID and/or password or Wi-Fi Network data was entered incorrectly;
- d.** Internet Provider failures.

NOTE. To eliminate connection failures, follow instructions specified on corresponding screens of the smartphone.



D. LOCATION AND ROOM SETTING



After successful connection of the device, the User may specify the following:

- a.** Device name;
- b.** Device Location;
- c.** Room.

You can also select an image for the device by clicking on the "Tap to change image" link.

After completion, click on the **DONE** button.

The IoT Router will be displayed in the Devices tab.

The entire process of the IoT Router activation in the Mobile App is shown below.

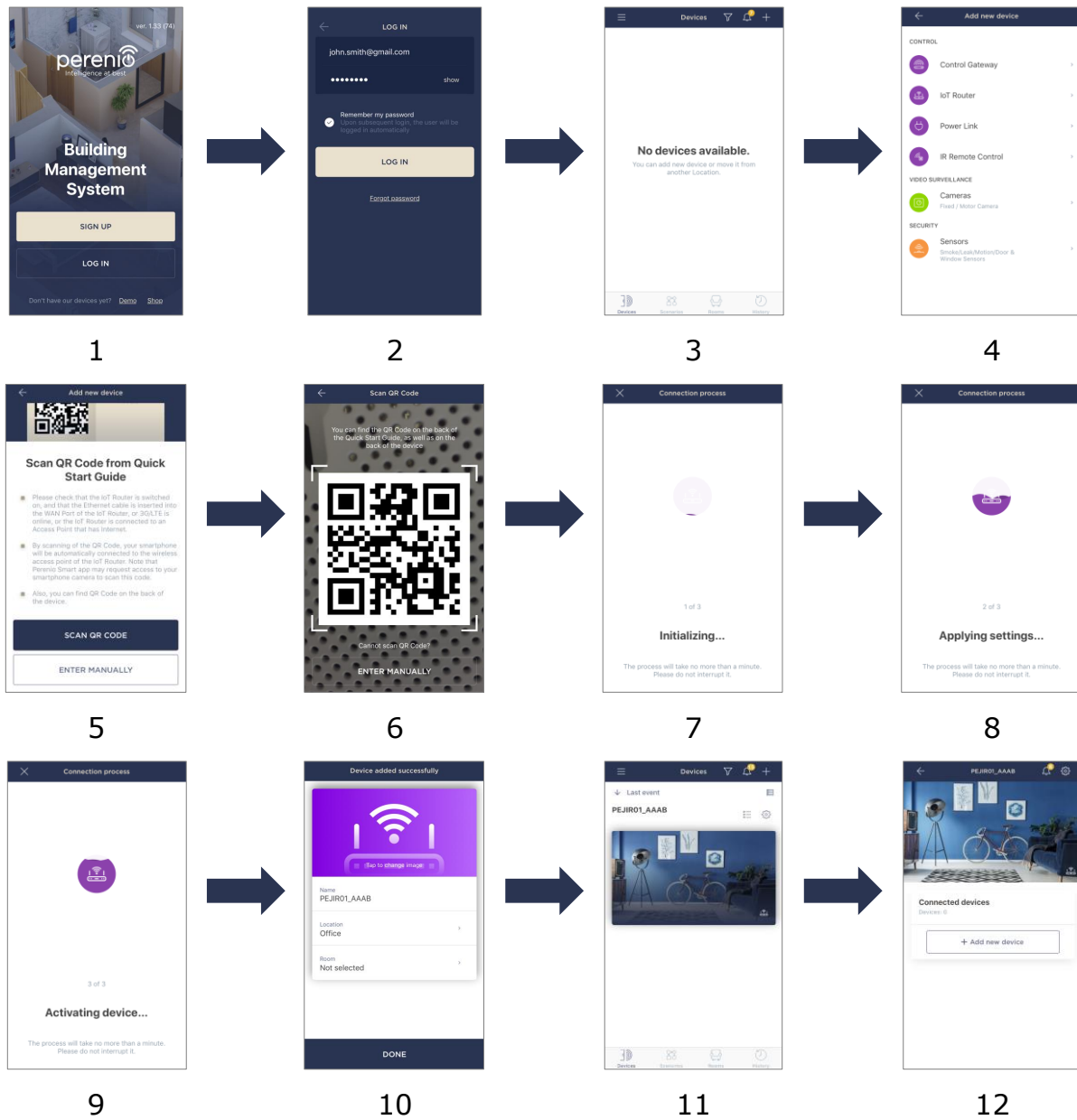


Figure 16 – Activation process

2.2 Resetting and Rebooting

Below see ways to reset or reboot the IoT Router:

1. **Reboot the device with full saving of settings** performed in both the web interface and the **Perenio Smart** application. To do this, follow below steps:
 - a. Make sure the IoT Router is turned on;

- b. Press and hold the reset button for 1 second (LED indicators will turn blue and go out after one second on the device casing);

IMPORTANT! A SIM Card tray staple supplied with the device shall be used to press the reset button located on the back of the IoT Router casing.

- c. Wait for the IoT Router reboot process to be completed (See par. 2.1.1).

NOTE that the User may also restart the device from the admin panel by clicking on the corresponding button in the upper right corner of the screen.



Figure 17 – Location of the reset button

This method may be used in the following cases:

- Access points of the IoT Router are not displayed in the list of available Wi-Fi networks;
- Admin panel login page is not displayed, or an error occurred upon entering the IP address of the device in a browser bar;
- Power button flashes or blinks red fast.

2. Partial factory reset without rebooting the device (i.e. reset of IoT settings only). To do this, follow below steps:

- a. Make sure the IoT Router is turned on;
- b. Press and hold the reset button for 8 seconds until LED indicators on the casing flashes bright white;

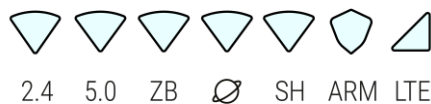


Figure 18 – Indicators after holding the reset button for 8 seconds

IMPORTANT! A SIM Card tray staple supplied with the device shall be used to press the reset button located on the back of the IoT Router casing.

- c. Wait until LED indicators start blinking in the operating mode (See Table 1 – LED Indicator Statuses).

NOTE that the User may also reset IoT settings from the admin panel by clicking on the “Disconnect” button in the “IoT” tab.

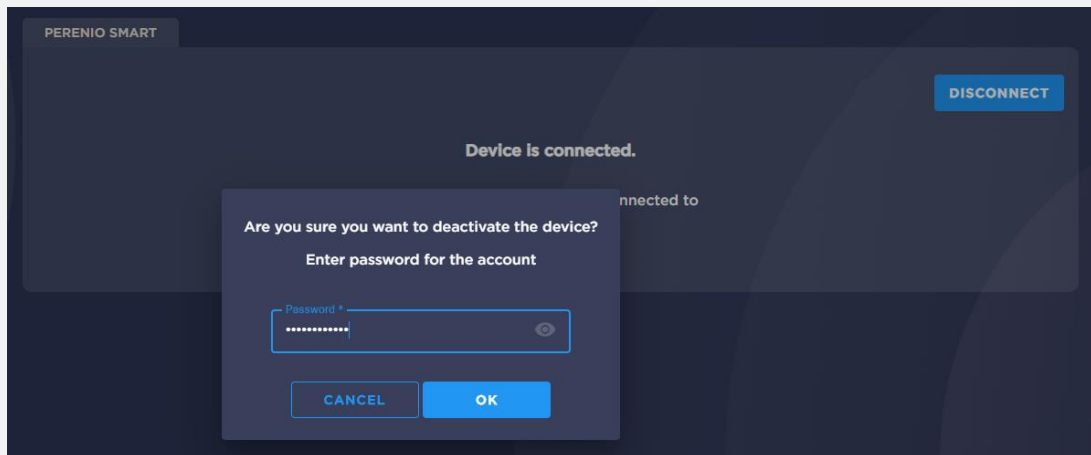


Figure 19 – Deactivation of the device in the mobile application

This method may be used in the following cases:

- The User disconnected the IoT Router from his/her account in the **Perenio Smart** application during the period when the IoT Router was offline;
- There is a need to reset only those settings that are related to activation of the IoT Router to the **Perenio Smart** application.

IMPORTANT! After such a reset, the IoT Router will switch to “Offline” state in the **Perenio Smart** mobile app.

3. **Hard reset including the device reboot.** To do this, follow below steps:
 - a. **Turn off** the IoT Router by pressing and holding the power button for **2 seconds (Do not unplug the device from the mains!)**;
 - b. Press and hold the reset button;

IMPORTANT! A SIM Card tray staple supplied with the device shall be used to press the reset button located on the back of the IoT Router casing.

- c. Without releasing the reset button, **turn on** the IoT Router by pressing the power button once and wait for LED indicators flash bright white;
- d. Release the reset button after LED indicators start blinking bright white fast on the device casing (Pressed button shall be held for 8 seconds);
- e. Wait for completion of the two stages of the IoT Router reboot (The second reboot starts after the fifth module is loaded – See Figure below).

NOTE that the User may cancel the hard reset process during Step **e**) by turning off the IoT Router (using the power button) before the first five LEDs turn solid blue during the stage of first reboot.

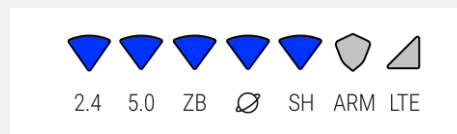


Figure 20 – The moment of reboot, when it is no longer possible to cancel the hard reset

NOTE that the User may also reset all settings from the admin panel by clicking on the “Reset” button in the “System” – “Backup/Flashing” tab.

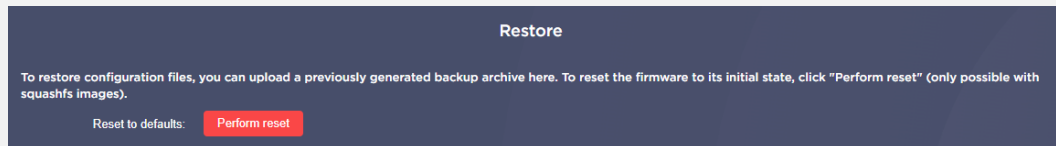


Figure 21 – Location of the button to perform hard reset

This method may be used in the following cases:

- The User applied incorrect settings, which resulted in the IoT Router freezing while rebooting;
- Freezing of the IoT Router for an unknown reason (All indicators are off or on, the device keeps rebooting).

2.3 Ethernet Connection

Connection to Elegance IoT Router access points may be performed in one of the following ways:

- Via Wi-Fi;
- Via Ethernet cable.

2.4 Wi-Fi Protected Setup (WPS)

The WPS function is used to securely configure a wireless network with no need to enter a Wi-Fi network password.

NOTE that during the WPS connection process Wi-Fi Network indicators (2.0 and 5.0) will be blinking violet.

The connection process shall be as follows:

1. Connecting a PC or a laptop:

- a. Go to the list of available Wi-Fi networks on your PC or laptop;
- b. Select the access point of the configured IoT Router from the list;
- c. Click on the "Connect" button;
- d. Wait for the security key popup window to be displayed on the screen;
- e. Press and hold the WPS button on the IoT Router for 1-2 seconds to start the connection process (The power button LED indicator will blink once);
- f. Wait for the connection process to be completed.

NOTE that if "You can also connect by pressing a button on the router" message is not displayed in the security key popup window, then your PC does not support the WPS button connection function.

2. Connecting a smartphone or a tablet:

- a. Go to settings screen of your smartphone or tablet;
- b. Select the list of available Wi-Fi networks;
- c. Select "Advanced settings" or "Additional" (it depends on the device model);
- d. Select the type of connection using the WPS button;
- e. Wait for the WPS settings window to be displayed on your smartphone or tablet screen;

- f. Press and hold the WPS button on the IoT Router for 1-2 seconds to start the connection process (The power button LED indicator will blink once);
- g. Wait for the connection process to be completed.

NOTE that if "WPS by button", "Use WPS", "WPS button", etc. option is not displayed in advanced or additional settings of Wi-Fi networks, then this tablet or smartphone does not support the WPS button connection function.

2.5 History and Push-Notifications

All notifications and other messages including changes in the status of **Perenio[®]** devices are displayed in the "History" tab. The most important messages can be viewed online in the "🔔" notification window in your account.

The following types of notifications are available:

- (Critical) alarms (They always come as push notifications to your smartphone, and are also displayed in the notification window, as well as in the "History" tab of the mobile app; The indication color is red);
- Important messages (They are always displayed in the notification window and the "History" tab; The indication color is yellow);
- Typical events (They are displayed in the "History" tab only; The indication color is not available).

Alarms. These are the most important messages, which include notifications about the following events:

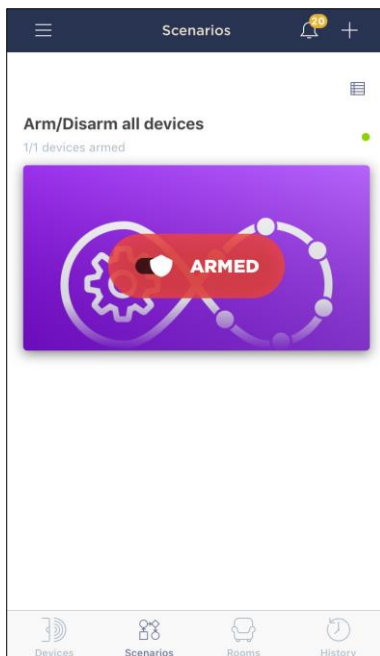
- IoT Router battery charging is low;
- The IoT Router runs on battery;
- Motion detection by the camera;
- There is not enough space on the SD card to continue recording video;
- Change of the camera status to "Offline";
- Sensor triggering in the armed mode, including all alarms from smoke and leak sensors (even when the Location is in the disarmed mode);
- Disabling the sensor armed mode;
- Failure to perform the scenario;
- Connection of a dangerous device, and overloading the network (for the Power Link Wi-Fi Smart plug);
- Sudden changes or insufficient voltage, excessive power, temperature and/or consumption (for Power Link (ZigBee) Smart plug);

- Falls and/or overheats of the Eco Smart Heater, or sudden changes in voltage;
- Important updates.

Important messages. These are notifications on launches and completion of the camera and the Control Gateway firmware update, as well as notifications about low battery level of the sensor and changing the armed mode for the Location.

Typical Events. Various Perenio IoT newsletters, as well as messages about triggering Door & Window/Motion sensor in the disarmed mode.

2.6 Armed Mode



If provided by the IoT Router configuration, the device may notify users on ZigBee device actuation, if such devices are switched to the Armed mode in the **Perenio Smart** mobile application.

The following signal types are available:

- Blinking ARM indicator on the device casing;
- Beeping*;
- Push-notifications to smartphone.

Light and sound signals will be stopped after the activated device is disarmed in the User Account.

NOTE that as of the date of issue of the current version of the manual, this function is not available.

* Some components, modules, and/or functions may not be available in your IoT Router configuration. See paragraph 1.2.

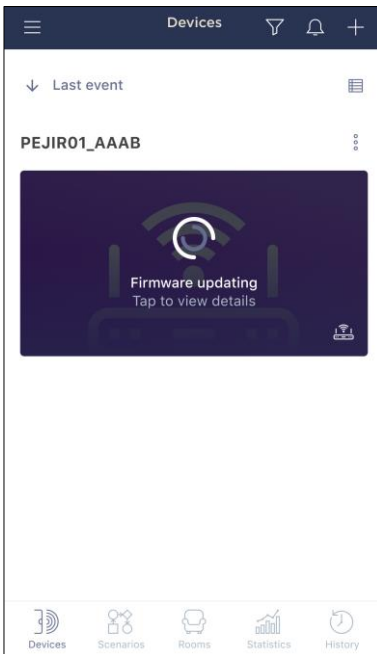
2.7 The Use of USB Storage Devices

The Elegance IoT Router is equipped with USB ports to connect external storage devices and share access thereto over a local network.

For details on sharing files and folders, see par. 3.8.1 below.

NOTE that the User must not unplug the IoT Router from the mains (i.e. do not switch the device to battery operation) if USB 2.0 and/or USB 3.0 ports are used.

2.8 Upgrading and Downgrading Firmware



Perenio IoT strives to constantly improve the quality of its products, so when the IoT Router is activated for the first time, as well as during its operation, an automatic software (firmware) update can be started.

In this case, the User will see a corresponding notification in the device control panel in the mobile application.

IMPORTANT! Do not unplug the device from the mains for at least **10 minutes** after the firmware update process is started.

During firmware update process, data about the IoT Router and connected sensors will be unavailable. Also, the device may reboot repeatedly.

It is allowed to switch off the device and/or reset its settings only after the update process is successfully completed, and a corresponding push-notification is received to the User's smartphone, as well as the IoT Router becomes online again (The black screen disappears).

NOTE that powering off the IoT Router during the firmware update process may lead to its malfunction. In this case, the User shall contact our Technical Support Department to restore factory settings.

See details on the initial firmware update in par. 2.1.3 above.

The User may also manually upgrade or downgrade the IoT Router firmware. It is strongly recommended never use this option unless instructed by the *Perenio IoT* Technical Support Department.

For manual firmware upgrading, please see par. 3.7.3 below.

Downgrading to a previous firmware version shall be performed as follows:

1. **Turn off** the IoT Router by pressing and holding the power button for **2 seconds (Do not unplug the device from the mains!)**;
2. Press and hold the reset button;

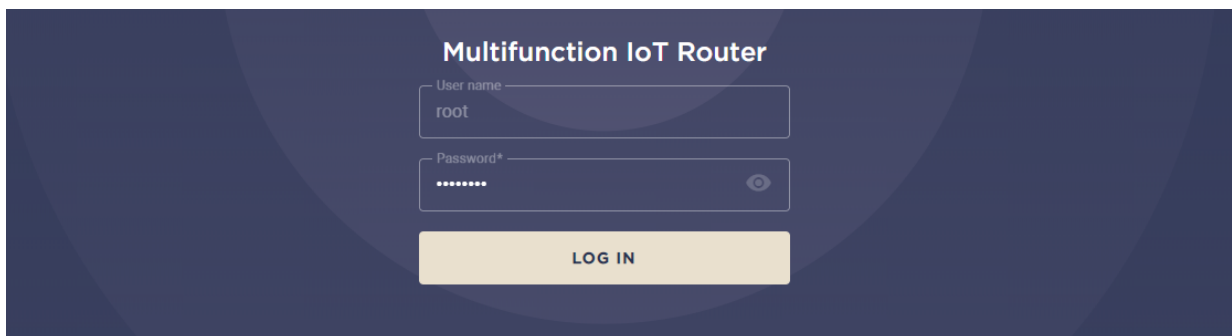
IMPORTANT! A SIM Card tray staple supplied with the device shall be used to press the reset button located on the back of the IoT Router casing.

3. Without releasing the reset button, press and hold the power button;
4. Release both the reset button and the power button at the same time after LED indicators start blinking bright white;
5. Wait for completion of the IoT Router reboot).

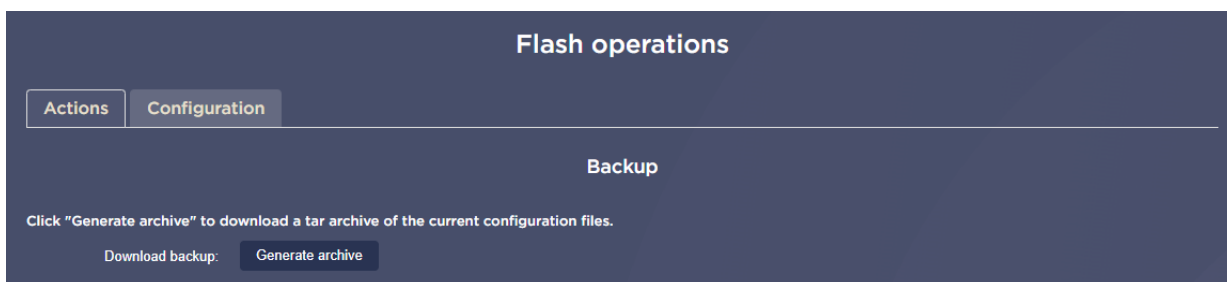
2.9 Log Downloading

To download a complete archive of IoT Router settings, including logs and config-files, follow the below steps:

1. Log in to the admin panel of the IoT Router.



2. In the left menu, select "System" – "Backup/Flashing".
3. In the "Backup" section, click on the "Create archive" button.

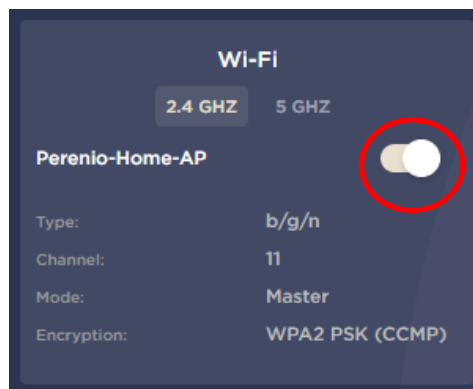


4. ".tar.gz" archive will be downloaded.

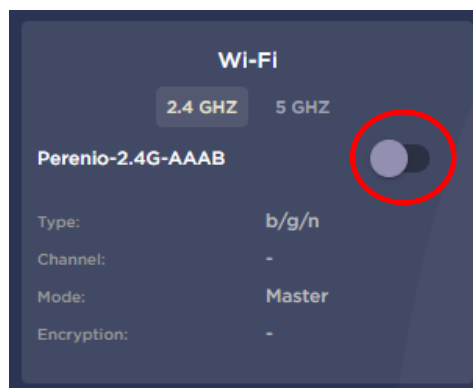
2.10 Management of Wi-Fi Access Points

The User may disable and/or enable Wi-Fi access points of the Elegance IoT Router remotely from the admin panel in any of the following ways:

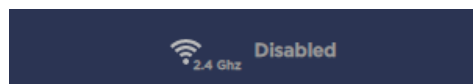
1. Go to the "Status" – "Overview" tab and select the required access point (2.4GHz or 5GHz) in the "Wi-Fi" block, then click on the toggle switch located to the right of the name of the selected access point.



Wait for settings to be applied.



The current status of the access point will be displayed in the top panel.

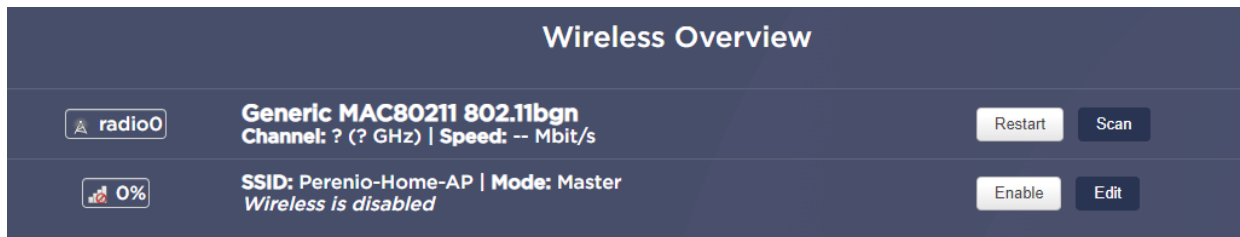


2. Go to the "Network" – "Wireless" tab and click on the "Disable"/"Enable" button located next to the required access point in the list of wireless networks.



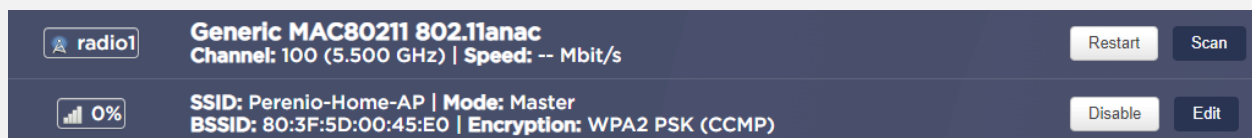
Wait for settings to be applied.

The current state of the access point will be displayed under its name.

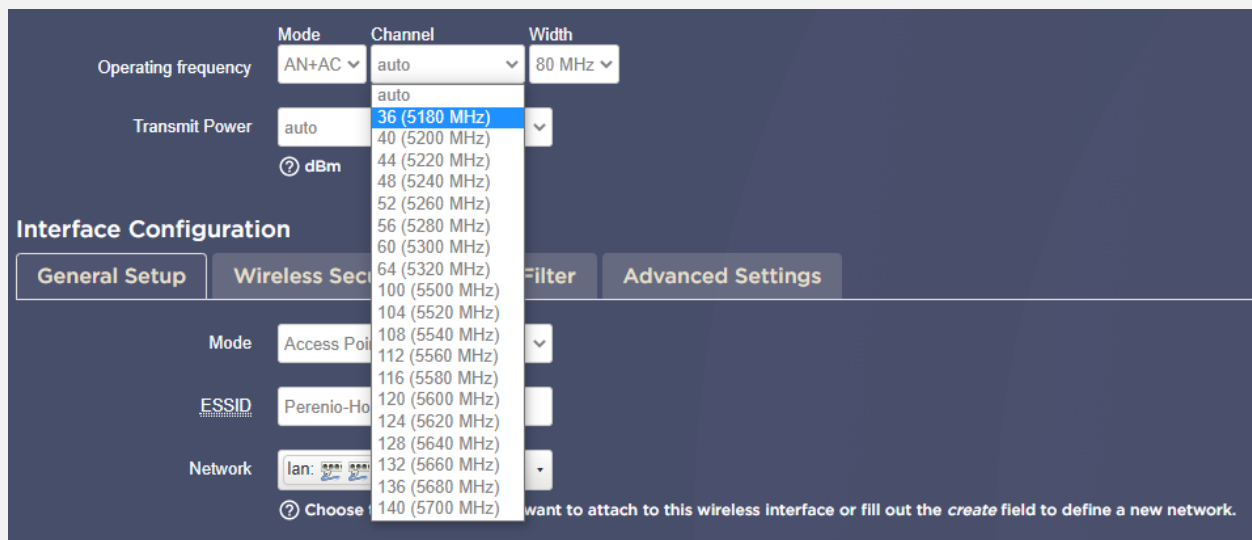


NOTE that certain channels of 5GHz networks are blocked on the territory of some countries, so Users of some models of mobile devices may not see the 5GHz IoT Router access point in the list of available Wi-Fi networks.

To fix this problem, go to "Network" – "Wireless" tab and click on the "Edit" button next to the 5GHz access point.



Then, select one of the allowed channels in the drop-down list of "Operating Frequency" block. Click on the "Save" button to apply settings.



The list of channels allowed on the territory of the User's country of residence can be found out from open sources on the Internet.

3 Admin Panel Interface

After initial configuration of the Elegance IoT Router, the User may make additional settings in the admin panel.

The admin panel consists of the following sections and tabs:

1. Top panel.
2. Bottom panel.
3. Quick setup section.
4. Advanced mode section.
5. Status tab.
6. System tab.
7. Services tab.
8. Network tab.
9. IoT tab.

NOTE that the present Section contains information on basic settings available to Users. Subsections and tabs not described in this document are considered intended for use by technical support specialists and/or warranty and post-warranty service personnel with a certain level of qualifications and special knowledge. The User is not recommended to make additional settings or change the IoT Router configuration on their own, unless it is described in the present manual, as this may result in performance or breakdown of the device.

3.1 Login to the admin panel

- a) Establish a connection between devices (See Step 1 and Step 2 in par. 2.1.2);
- b) Launch any web browser;
- c) Enter the IP address of the IoT Router (**192.168.1.1**) in the address bar;
- d) Press "Enter";
- e) Enter login and password specified on the sticker at the bottom of the IoT Router or in the Quick Start Guide;
- f) Click on "**LOG IN**" button.



Figure 22 – Login screen of the admin panel

3.2 Top Panel

The top panel of the admin panel contains the following icons and buttons:

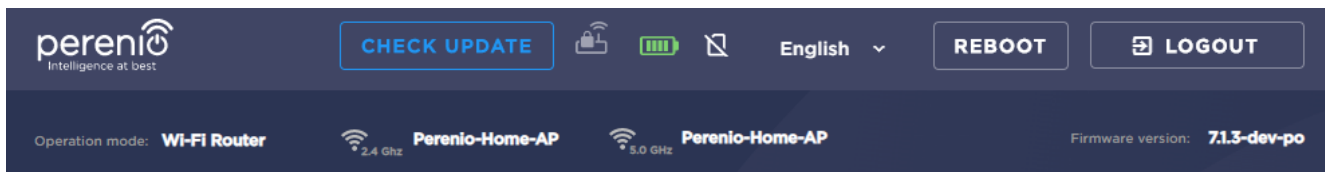


Figure 23 – Icons and buttons in the top panel

1. Perenio logo.

It is intended to go back to the "Status" tab from any other screen in the admin panel, including quick setup section.

2. Unaccepted changes.

It is displayed in the presence of any changes to the config-file that were not accepted by the User. When such a message appears, it is recommended to click on it and accept changes listed in the screen.

3. Button to check for firmware updates.

It is designed to check if the IoT Router firmware shall be updated, as well as to start the update process.

4. Battery icon.

It shows the state and the current charge level of the built-in battery, as well as cases of using an incompatible power adapter and the lack of connection to the mains (For more details, see Table 5 in par. 3.6.1 below).

Also, by clicking on this icon, the User may also turn on the Smart Battery mode, which allows to extend the battery life by switching it into standby mode at 100% charge level.

5. SIM Card icon.

When the SIM card is inserted, it displays the signal quality and the technology used (4G/LTE, EDGE, HSPA – for details, see indication in Table 5 in par. 3.6.1 below).

6. Language.

Option to select the language for the admin panel.

7. Reset button.

It is designed for remote reboot of the device with saving of all settings (See par. 2.2 above).

8. Button to exit the admin panel.

It is designed to exit the admin panel and go to the login and password entry screen (See Step 4 in par. 2.1.2 above).

9. Current mode.

It means the IoT Router operating mode. The following mode is currently possible:

- Wi-Fi Router.

10. Active access points.

Names of active access points of the IoT Router are displayed here. If the Wi-Fi Client mode was used, one of access points will be marked as "Client", and it will not be visible in the list of available Networks. If any of the access point will be disabled by the User, it will be marked as "Off".

11. Current firmware version.

The version of the IoT Router firmware is displayed here.

3.3 Bottom Panel

The bottom panel of the admin panel contains the address of the *Perenio IoT* website, which you can visit by clicking on its name, as well as links to download the **Perenio Smart** mobile application from the App Store or Google Play.



Figure 24 – Icons in the bottom panel

3.4 Quick Setup

This button is used to go to IoT Router settings as described in par. 2.1.2 and par. 2.1.3.

3.5 Advanced mode

This mode is intended to be used by *Perenio IoT* technical support specialists in order to identify possible causes of a malfunction of the IoT Router.

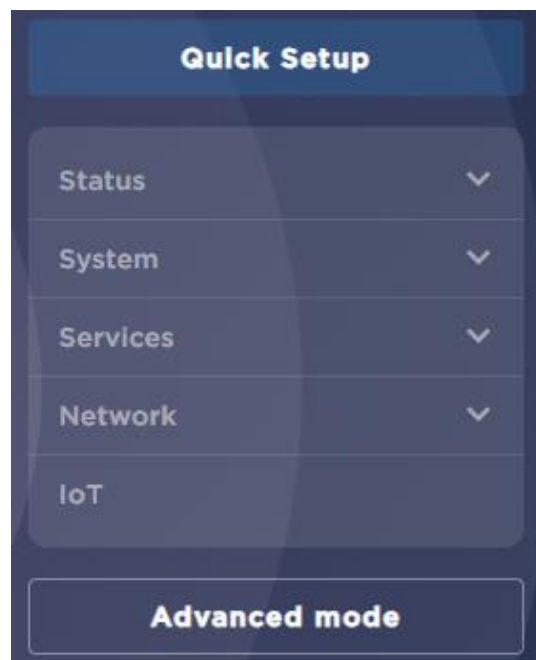


Figure 25 – Location of buttons for quick setup and advanced mode

3.6 Status Tab

This tab is the main screen displayed when the User logs in to the admin panel. Basic information about the device status is displayed here.

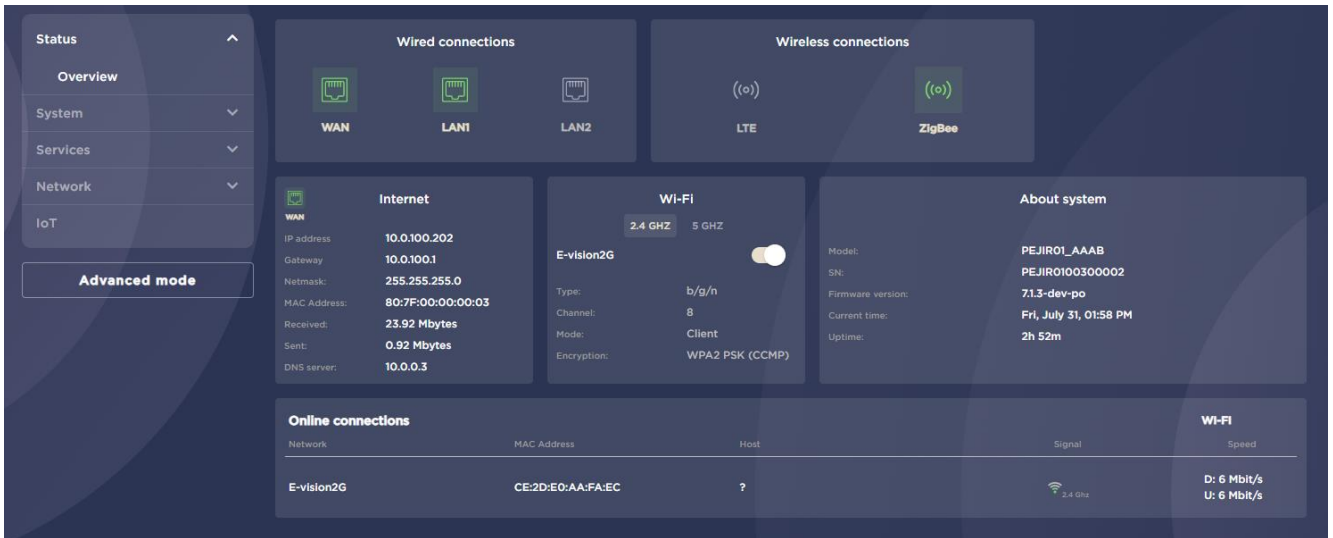







































Figure 26 – Status tab Screen

The screen is divided into the following blocks:

- **Wired connections**, where active/disabled ports on the IoT Router casing are visually displayed;
- **Wireless connections**, where active/disabled ZigBee, Z-Wave, LTE and Bluetooth modules are visually displayed;
- **Internet**, where the User can view information about MAC- and IP addresses;
- **Wi-Fi**, where info about 2.4GHz and 5GHz access points is visually displayed;
- **General info about system**, including device model, firmware version and serial number;
- **Online connections** currently available, including information about connected devices.































3.6.1 Basic Buttons and Indicators

Table 5 – Buttons and indicators in the admin panel

Icons	Description and Designation		
	<p>Indication of the built-in battery level and state. The following states are possible:</p>		
	<table border="1"> <tr> <td data-bbox="392 622 480 701"></td> <td data-bbox="504 622 1366 701">The device is plugged into the mains and charged (Charge level: 100%)</td> </tr> </table>		The device is plugged into the mains and charged (Charge level: 100%)
		The device is plugged into the mains and charged (Charge level: 100%)	
	<table border="1"> <tr> <td data-bbox="392 723 480 790"></td> <td data-bbox="504 723 1366 790">The device is battery operated (Charge level: 75% to 99%)</td> </tr> </table>		The device is battery operated (Charge level: 75% to 99%)
		The device is battery operated (Charge level: 75% to 99%)	
	<table border="1"> <tr> <td data-bbox="392 813 480 880"></td> <td data-bbox="504 813 1366 880">The device is plugged into the mains and charging (Charge level: 75% to 99%)</td> </tr> </table>		The device is plugged into the mains and charging (Charge level: 75% to 99%)
		The device is plugged into the mains and charging (Charge level: 75% to 99%)	
	<table border="1"> <tr> <td data-bbox="392 902 480 969"></td> <td data-bbox="504 902 1366 969">The device is battery operated (Charge level: 50% to 74%)</td> </tr> </table>		The device is battery operated (Charge level: 50% to 74%)
		The device is battery operated (Charge level: 50% to 74%)	
	<table border="1"> <tr> <td data-bbox="392 992 480 1059"></td> <td data-bbox="504 992 1366 1059">The device is plugged into the mains and charging (Charge level: 50% to 74%)</td> </tr> </table>		The device is plugged into the mains and charging (Charge level: 50% to 74%)
		The device is plugged into the mains and charging (Charge level: 50% to 74%)	
	<table border="1"> <tr> <td data-bbox="392 1081 480 1149"></td> <td data-bbox="504 1081 1366 1149">The device is battery operated (Charge level: 10% to 49%)</td> </tr> </table>		The device is battery operated (Charge level: 10% to 49%)
		The device is battery operated (Charge level: 10% to 49%)	
<table border="1"> <tr> <td data-bbox="392 1171 480 1238"></td> <td data-bbox="504 1171 1366 1238">The device is plugged into the mains and charging (Charge level: 10% to 49%)</td> </tr> </table>		The device is plugged into the mains and charging (Charge level: 10% to 49%)	
	The device is plugged into the mains and charging (Charge level: 10% to 49%)		
<table border="1"> <tr> <td data-bbox="392 1261 480 1328"></td> <td data-bbox="504 1261 1366 1328">The device is battery operated (Charge level: 0% to 9%)</td> </tr> </table>		The device is battery operated (Charge level: 0% to 9%)	
	The device is battery operated (Charge level: 0% to 9%)		
<table border="1"> <tr> <td data-bbox="392 1350 480 1417"></td> <td data-bbox="504 1350 1366 1417">The device is plugged into the mains and charging (Charge level: 0% to 9%)</td> </tr> </table>		The device is plugged into the mains and charging (Charge level: 0% to 9%)	
	The device is plugged into the mains and charging (Charge level: 0% to 9%)		
<table border="1"> <tr> <td data-bbox="392 1440 480 1507"></td> <td data-bbox="504 1440 1366 1507">The device is overheated (необходимо дать ему охладиться либо выбрать другое место установки)</td> </tr> </table>		The device is overheated (необходимо дать ему охладиться либо выбрать другое место установки)	
	The device is overheated (необходимо дать ему охладиться либо выбрать другое место установки)		
<table border="1"> <tr> <td data-bbox="392 1529 480 1597"></td> <td data-bbox="504 1529 1366 1597">Incompatible power adapter is used to charge the device</td> </tr> </table>		Incompatible power adapter is used to charge the device	
	Incompatible power adapter is used to charge the device		
<table border="1"> <tr> <td data-bbox="392 1619 480 1686"></td> <td data-bbox="504 1619 1366 1686">Battery is not detected (Follow instructions specified on the screen)</td> </tr> </table>		Battery is not detected (Follow instructions specified on the screen)	
	Battery is not detected (Follow instructions specified on the screen)		

If the battery level indicator is blinking, it means that the device is battery operated.

Also, when the User clicks on the battery icon, the Smart Battery mode activation window is displayed.

Icons	Description and Designation										
	<p>Signal strength and mobile network status indication. The following options are possible:</p> <table border="1"> <tr> <td data-bbox="427 495 518 577"></td> <td data-bbox="518 495 1482 577">4G/LTE technology is used for connection</td> </tr> <tr> <td data-bbox="427 577 518 660"></td> <td data-bbox="518 577 1482 660">EDGE technology is used for connection</td> </tr> <tr> <td data-bbox="427 660 518 743"></td> <td data-bbox="518 660 1482 743">HSPA technology is used for connection</td> </tr> <tr> <td data-bbox="427 743 518 826"></td> <td data-bbox="518 743 1482 826">No connection</td> </tr> <tr> <td data-bbox="427 826 518 931"></td> <td data-bbox="518 826 1482 931">No SIM Card</td> </tr> </table>		4G/LTE technology is used for connection		EDGE technology is used for connection		HSPA technology is used for connection		No connection		No SIM Card
	4G/LTE technology is used for connection										
	EDGE technology is used for connection										
	HSPA technology is used for connection										
	No connection										
	No SIM Card										
	<p>Indication of the wired signal state. The following states are possible:</p> <table border="1"> <tr> <td data-bbox="427 1055 518 1137"></td> <td data-bbox="518 1055 1482 1137">The cable is plugged into the port, the signal is normal</td> </tr> <tr> <td data-bbox="427 1137 518 1220"></td> <td data-bbox="518 1137 1482 1220">The cable is plugged into the port, there is no signal</td> </tr> <tr> <td data-bbox="427 1220 518 1303"></td> <td data-bbox="518 1220 1482 1303">The cable is not plugged into the port</td> </tr> </table>		The cable is plugged into the port, the signal is normal		The cable is plugged into the port, there is no signal		The cable is not plugged into the port				
	The cable is plugged into the port, the signal is normal										
	The cable is plugged into the port, there is no signal										
	The cable is not plugged into the port										
	<p>Indication of the wireless signal status. The following states are possible:</p> <table border="1"> <tr> <td data-bbox="427 1424 518 1507"></td> <td data-bbox="518 1424 1482 1507">The signal is normal</td> </tr> <tr> <td data-bbox="427 1507 518 1590"></td> <td data-bbox="518 1507 1482 1590">The signal is weak</td> </tr> <tr> <td data-bbox="427 1590 518 1673"></td> <td data-bbox="518 1590 1482 1673">No signal</td> </tr> </table>		The signal is normal		The signal is weak		No signal				
	The signal is normal										
	The signal is weak										
	No signal										

3.7 System Tab

The present tab consists of the following three subtabs:

1. System.
2. Administration.
3. Backup/Flash Firmware.

3.7.1 System

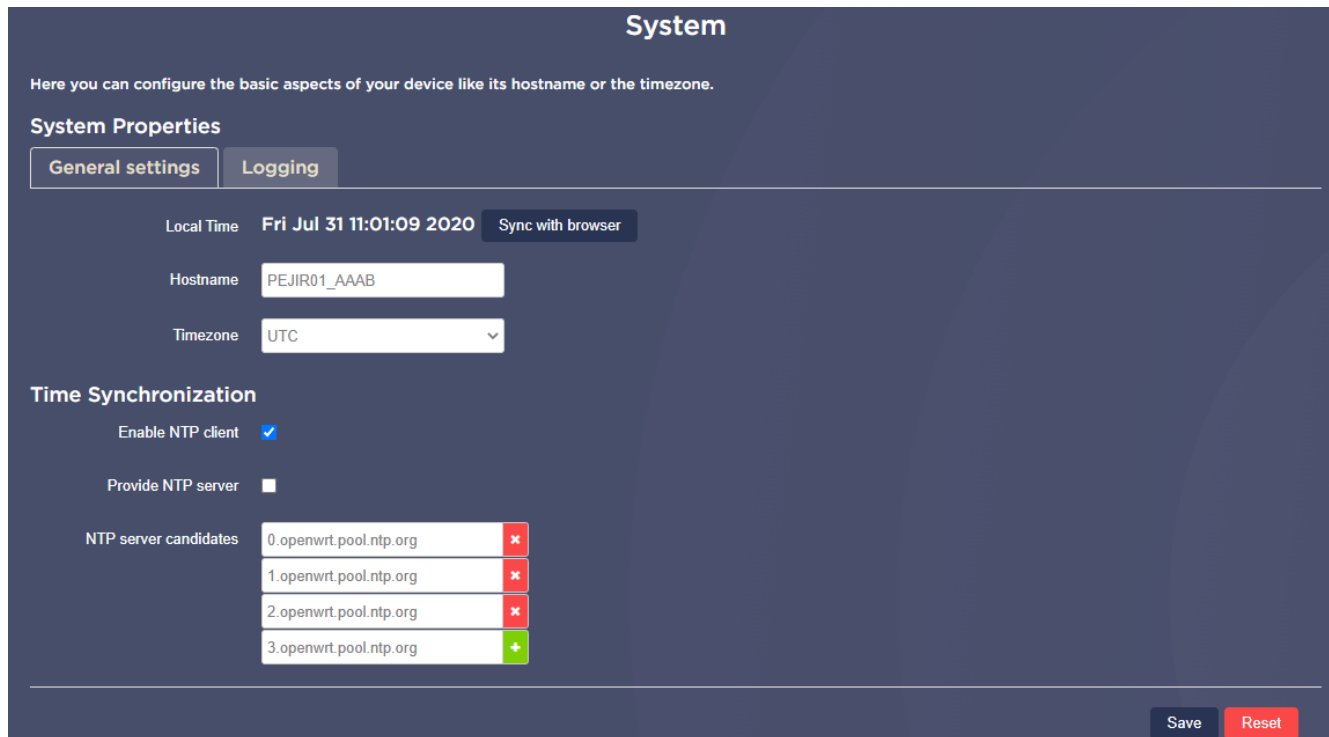


Figure 27 – “System” – “System Properties” Screen

Below see settings that can be made in the “System Properties” tab:

1. Setting and changing the time zone;
2. Time synchronization with the browser;
3. Time synchronization with the NTP Server.

Table 6 – Description of the main parameters of the “System” tab

Name	Description
Local Time	The current time is displayed based on the time zone set
Sync with browser	Button to synchronize the time of the IoT Router with the time of the Internet browser
Hostname	The name that is assigned to the IoT Router and allows access to it without using IP address

Name	Description
Time Zone	Option to select time zone for the device
Enable NTP Client	If checked, time received by the IoT Router will be synchronized with the specified NTP servers
Provide NTP Server	If checked, time of devices connected to the IoT Router will be synchronized with the time of the IoT Router
NTP Server Candidates	List of NTP servers used for time synchronization
Save	Button to save settings (Settings will not be applied)
Reset	Button to reset not saved settings

NOTE that if the option to synchronize time with the browser is selected, it will be used until the IoT Router is rebooted. After rebooting, time will be checked against time of specified NTP servers.

3.7.2 Administration

In this tab, the User can change the password of the admin panel.

Figure 28 – Changing the admin panel password

Table 7 – Description of the main parameters of the “Control” tab

Name	Description
Password	Field for entering a new password of the admin panel
Confirm password	Field for re-entering the new password of the admin panel
Change	Button to confirm password changed

NOTE that the User Account password must be 8 or more symbols including at least one uppercase letter, one lowercase letter and one number. It is allowed to use !@#%^&*._ symbols. In the case of hard reset of the IoT Router, the User-defined admin panel password will also be reset to the default value.

3.7.3 Backup/Flash Firmware

In this tab, the User can download a backup copy of the IoT Router’s firmware configuration, as well as reset all device settings to default values.

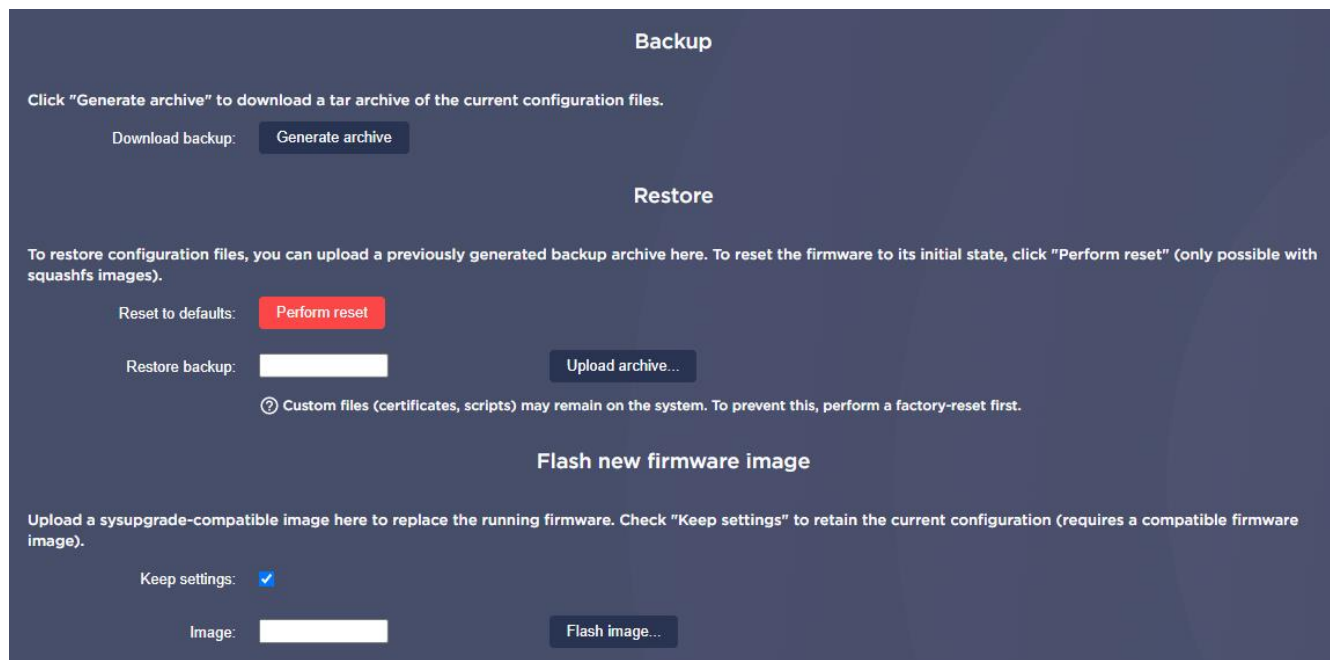


Figure 29 – “System” – “Backup/Flash Firmware” Screen

Table 8 – Description of the main parameters of the “Backup/Flash Firmware” tab

Name	Description
Backup	If a backup copy of the current firmware configuration and logs (tar-archive) is required, the User should click on the “Generate archive” button
Restore	To apply the saved backup copy of the firmware configuration, you must click on the “Reset” button, then re-enter this tab and download the tar-archive via the "Select file" option. Click on the

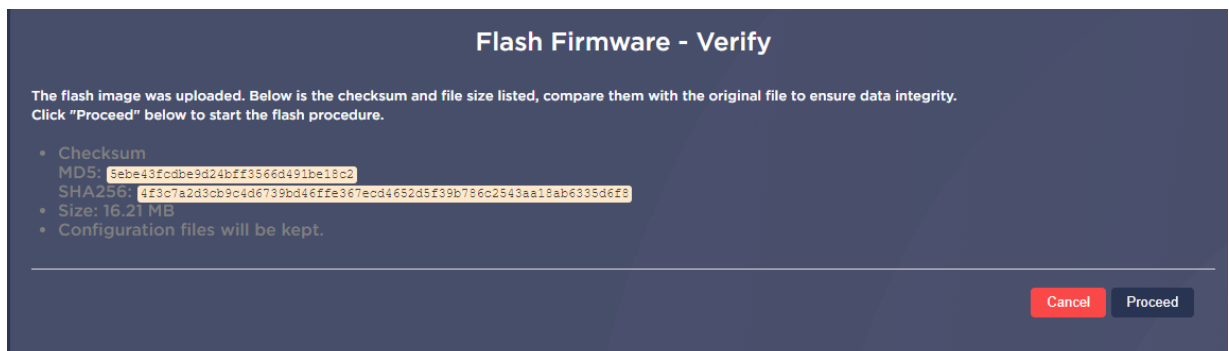
Name	Description
	"Upload archive" button and wait for the settings to be applied (The IoT Router will reboot)
Flash a new firmware version	This function is used to manually update the IoT Router firmware

NOTE. The "Reset" button can also be used to perform remote hard reset IoT Router settings.

Manual Firmware Flashing

NOTE that manual flashing of firmware shall be carried out in the case of corresponding recommendations from the Support Department.

1. To install the current firmware version, the User shall download a special archive containing the device name (for example, PEJIR01_firmware_v7.3.0_Perenio.zip) from the official website of the company by the following link: **perenio.com/documents** (Firmware Section) and unpack it on the device where the update process will be carried out.
2. In the "System" – "Backup/Flash Firmware" tab, the User shall upload the unpacked firmware file by clicking on the "Select file" button at the bottom of the screen (See Figure 29 above).
3. Click on the "Flash Image" button.
4. In the opened checksum verification window, click "Continue" button and wait for the installation process to be completed.



5. The device will be rebooted after successful firmware update.

3.8 Services Tab

The present tab consists of the following two subtabs:

1. Network Shares.
2. udpxy.

3.8.1 Network Resources

In this tab, the User may configure sharing of files from connected USB storage.

Name	Path→	Allowed users	Read-only	Browseable	Allow guests	Create mask Mask for new files	Directory mask Mask for new directories	
sda1	/mnt/sda1	root	<input type="checkbox"/>	<input checked="" type="checkbox"/>	<input checked="" type="checkbox"/>	0755	0755	Delete

Figure 30 – “Services” – “Network Shares” Screen

To set up file sharing, the below steps shall be followed:

1. Insert an external (USB Flash) storage device into the USB 2.0 or USB 3.0 port on the IoT Router casing.
2. Go to “Services” – “Network Shares” tab in the admin panel.
3. Set the hostname (i.e. the name that will be displayed as a public device name in the “Network” tab) and its description as may be required.

4. Specify the name of the workgroup (by default it is "WORKGROUP" or such other name as specified in the parameters of the workgroup in your PC/laptop settings).
5. Delete the "root" word from the "Allowed users" field in the "Shared Directories" section (See Figure above).
6. Specify the "0777" value in both fields of "Mask for new files/directories".
7. The rest shall be left as is.



8. Click on the "Save" button.
9. Go to the "Network" tab on your device (The User shall enable Network Discovery option in sharing settings, if disabled).

Contents of the external storage device will be displayed under the hostname specified in Step 2 above.

NOTE that contents of the external storage device may not be displayed in the "Network" tab, because the SMB 1 Protocol used by the IoT Router for sharing is disabled by default in some Windows operating systems. To enable it, check the box next to the "SMB 1.0/CIFS Client" option in Windows components section.

3.9 Network Tab

The present tab consists of the following six subtabs:

1. Interfaces.
2. Wireless.
3. Modem.
4. Firewall.
5. Diagnostics.
6. Load Balancing.

3.9.1 Interfaces

In this tab, current interface settings of the IoT Router are displayed, and they can be changed, stopped and restarted as needed.

To make changes to created connection or to set up a new connection, the User shall click on the "Edit" button.



After required changes are made, click on the "Save" button.

3.9.2 Wi-Fi

In this tab, the list of wireless networks of the IoT Router is displayed, and it can be changed, disabled and restarted as needed.

In this tab, data on connected Clients is also displayed, if any (For the Access Point Client Mode).



Figure 31 – "Network" – "Wireless" Screen

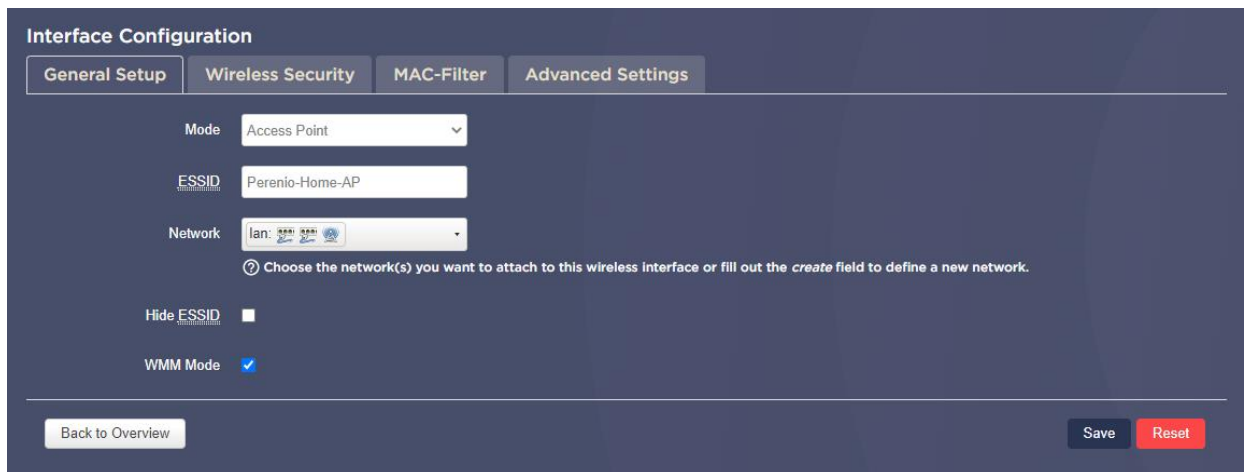
The User may change the name and the password of available networks as follows:

1. Changing the Wi-Fi Network name.

Select the network from the list which name is to be changed and click on the "Edit" button.

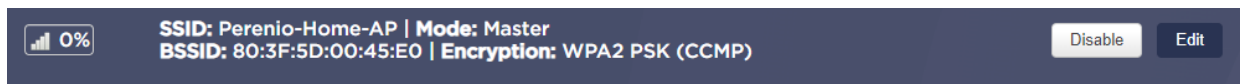


In the "Interface Configuration" – "General Setup" section, enter the desired name of the Wi-Fi network in the ESSID field, and click on the "Save" button.



2. Changing the Wi-Fi network password.

Select from the list the network whose password you want to change and click on the "Edit" button.



In the "Interface Configuration" - "Wireless security" section, enter the desired Wi-Fi network password in the "Key" field and click on the "Save" button.

3.9.3 Modem

In this tab, the User may view general information about the LTE Modem and the SIM Card, as well as manually configure the LTE connection and apply USSD codes to check the balance of the SIM Card, enable services, etc., if necessary.

Configuration shall be performed as follows:

1. Insert the nano-SIM Card into the IoT Router according to par. 2.1.6 of the present document.
2. Refresh the browser page in the admin panel to see information about the inserted SIM Card and the LTE Modem.

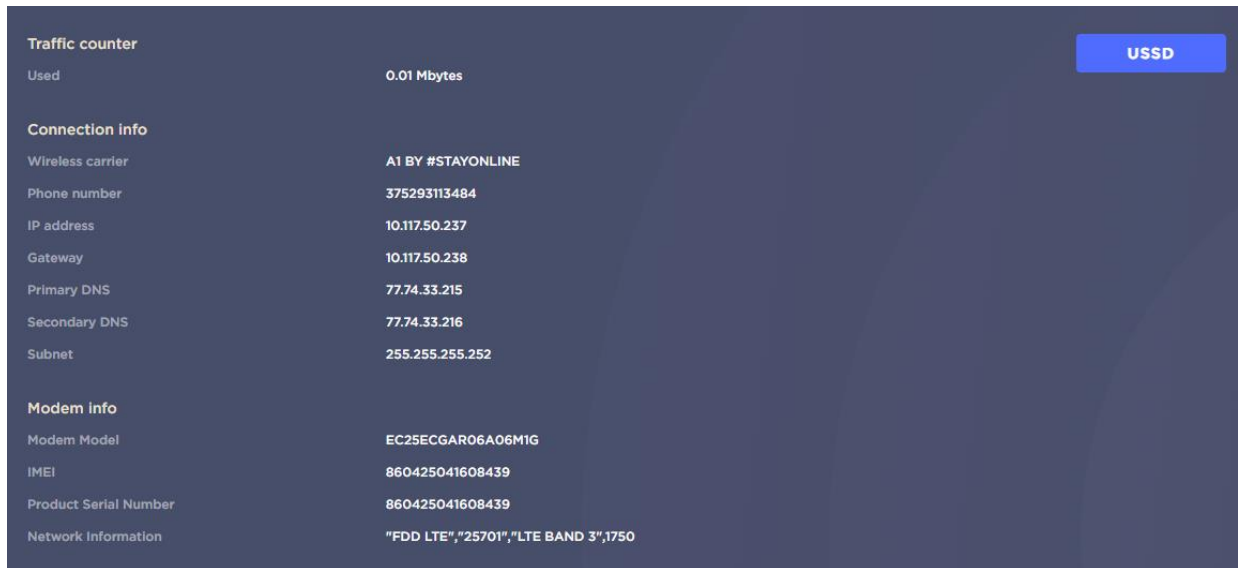


Figure 32 – “Network” – “Modem” Screen

3. Go to the “Modem” tab – “Modem settings”.
4. If the PIN Code of the SIM Card is enabled, enter it and disable the PIN Code by ticking a corresponding box. Click the “Done” button.
5. Enter the access point name, username and password, if such data was provided by the mobile operator, otherwise leave these fields as is.
6. Select the desired channel mode (LTE or 3G).

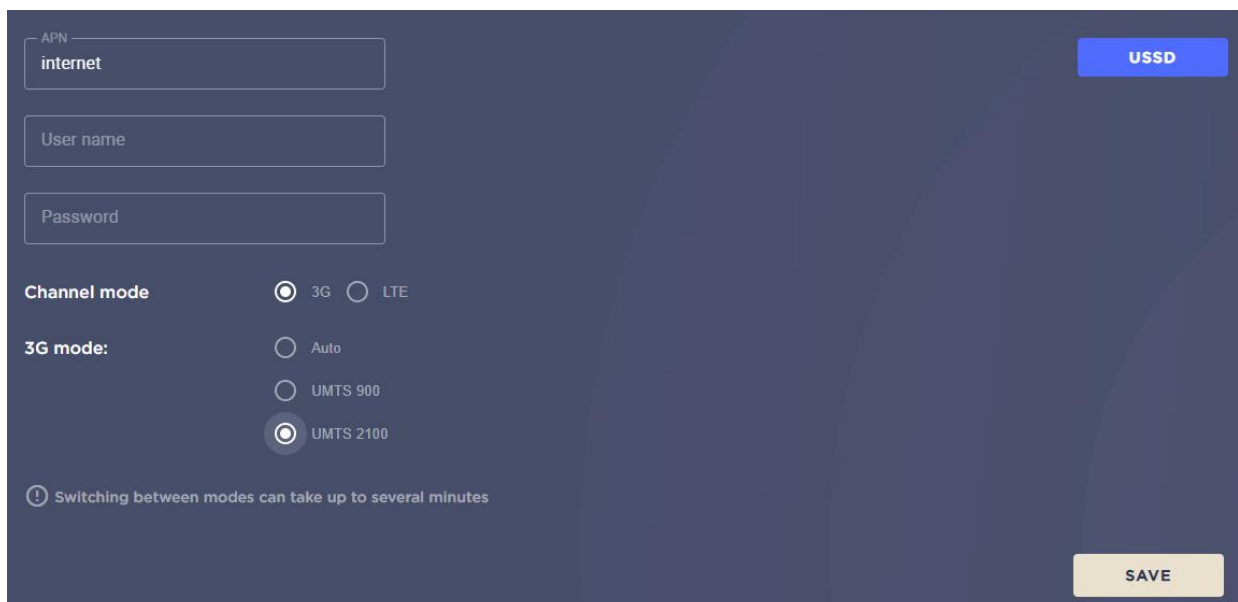


Figure 33 – “Network” – “Modem settings” Screen

NOTE that if the 3G Mode is selected, the User can also set a preferred network (UMTS-900 or UMTS-2100).

Choosing the UMTS-900 network may allow to significantly increase the 3G signal in rural areas, but remember that not all mobile devices support UMTS-900.

7. Click on the "Save" button.
8. Click on the "USSD" button in the upper right corner of the "Settings" tab to enter the USSD code, if necessary.

3.9.4 Diagnostics

In this tab, the User may run diagnostics of the Internet connection in order to find out possible causes of connection problems.



Figure 34 – "Network" – "Diagnostics" Screen

A ping query is used to check the connection integrity, while tracing is used to determine data routes, so that the User can see where the losses are happening, and a DNS query shows whether DNS servers are available at all.

3.9.5 Firewall

The firewall allows the User to control and filter the network traffic passing through, and create zones for the User's network.

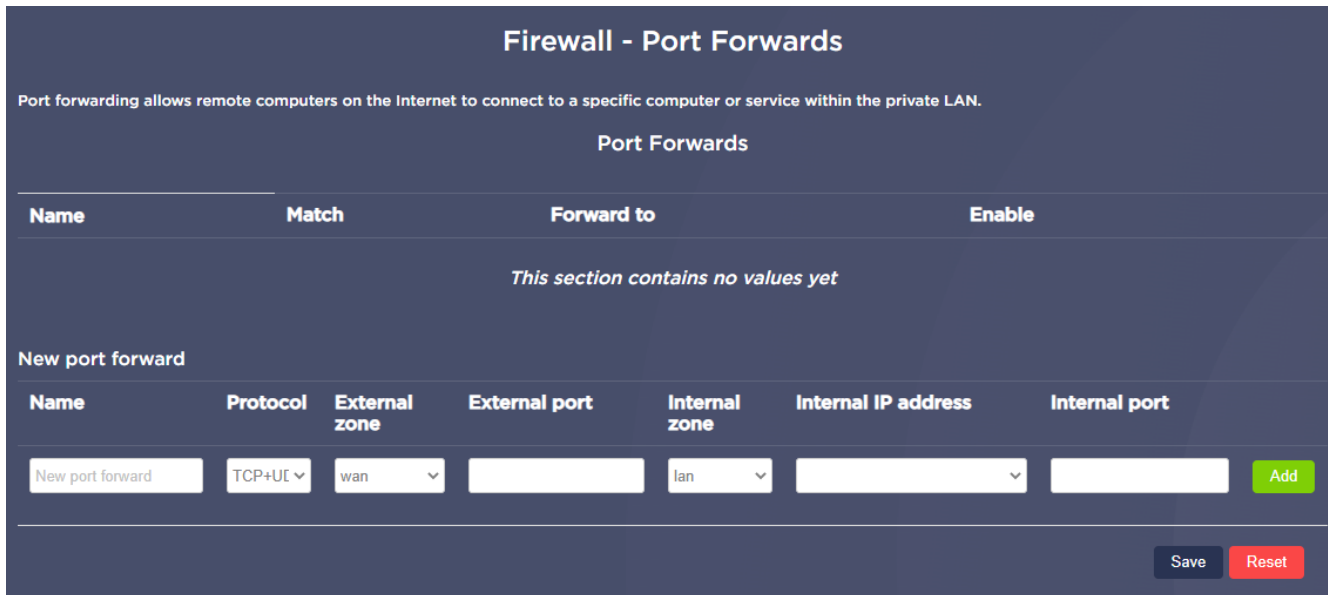


Figure 35 – “Network” – “Firewall” Screen

Traffic filtering is based on predefined rules and a description of acceptable and unacceptable data to be transferred.

Traffic can be:

- Accepted;
- Rejected;
- Not processed.

In this section, the User may also configure port forwarding, which allows them to remotely connect one PC to another PC or a service within a private local network.

In addition, it is possible to create custom rules, if the required commands are not covered by the firewall.

In this case, such commands will be executed after each reboot of the firewall (i.e. immediately after loading the default rule set).

3.9.6 Load Balancing

The User is able to customize the priority (metrics and weight) for available IoT Router connections (Router, Wi-Fi Client, 3G/4G) to improve the failure-free operation of the Internet connection.

By default, the priority for using available Internet connections is as follows:

1. Router Mode.
2. Wi-Fi Client Mode.
3. 3G/4G Connection.

For the User, it means that in the event of any ISP failure (Router Mode), the IoT Router will automatically switch to the Wi-Fi Client mode. And in the absence of this configured mode, to 3G/4G Connection option.

After ISP failure removal, the IoT Router will automatically return to a connection option of the highest priority (i.e. Router Mode).

However, the User has the right to change the priority of available Internet connections as follows:

- Go to the "WAN Traffic Balancing" tab – "Nodes";
- Select the interface, the priority of which should be changed and click on the "Change" button;
- Make corresponding changes to "Metrics" and "Weight" fields;

Table 9 – Description of the interface metric and weight settings

Name	Description
Interface	The name of the interface for which the priority is being changed
Metrics	A numeric value from 1 to 256 that determines the priority of the interface to get the minimum traffic route
Weight	A numeric value from 1 to 1000 that determines the priority of the specified metrics
Save and apply	Button to save and apply made settings

Name	Description
Save	Button to save (but not apply) made settings
Reset	Button to reset unsaved settings

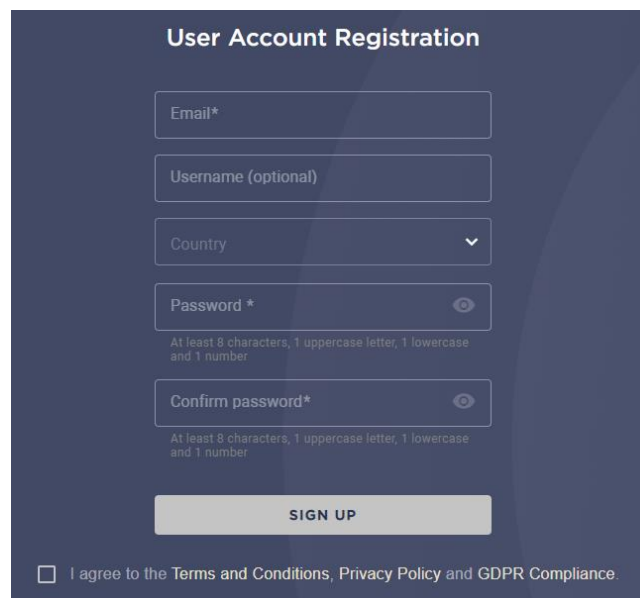
- Click on the "Save and Apply" button;
- Move edited interface to the desired position in the list of the "Nodes" tab using "Up" or "Down" button.

3.10 IoT Tab

In this tab, the User may register a new User Account in the **Perenio Smart** mobile application, as well as activate the IoT Router or disconnect it from the existing User Account.

New User Account Registration:

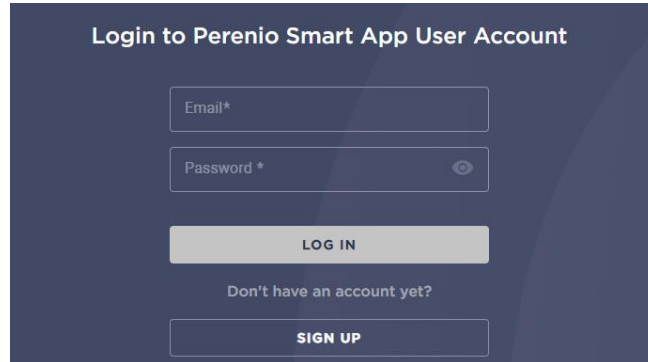
1. Enter your email address and password (The account password must be 8 or more symbols including at least one uppercase letter, one lowercase letter and one number. It is allowed to use !@#%^&*._ symbols).
2. Select the country of residence.
3. Click on the "Register" button.



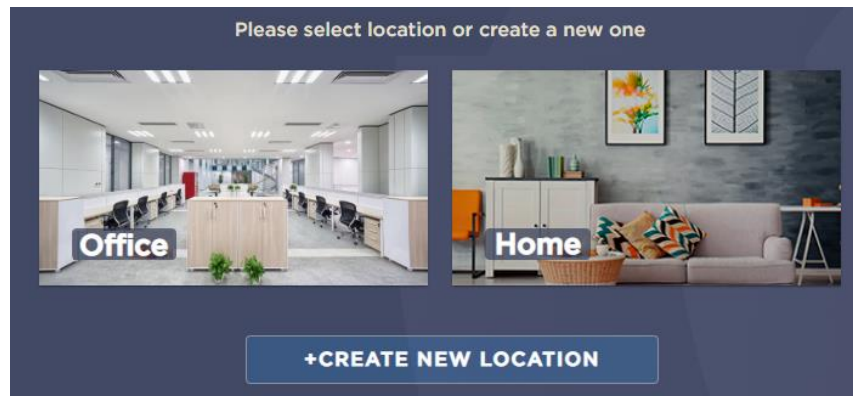
4. To complete registration, follow the link in the email that will be sent at the email address provided in Step 1.
5. Refresh the registration page in the admin panel.

Activation in the Perenio Smart mobile application:

1. Enter the username and the password of the **Perenio Smart** mobile application account, where it is necessary to activate the IoT Router.
2. Click on the "Login" button.



3. Select Location to connect or add new Location by clicking on a correspondent button.



4. After successful activation of the IoT Router, click "OK".

Deactivating the IoT Router in the mobile application:

1. Go to the IoT tab of the side panel.
2. Click on the "Disconnect" button.

Remote deactivation of the IoT Router in the mobile application means resetting all IoT Router settings. However, the device will remain visible in the list of devices in the mobile application in the "Offline" state.

To remove the IoT Router from the list of devices, the User shall go its settings in the User Account and click on the "Disconnect device" button.

4 Maintenance and Repair

The **Perenio® Elegance IoT Router** does not require special maintenance in the normal course of operation. However, in order to maintain the proper state and stable operation of devices it is recommended to perform the following actions from time to time:

- Clean the device casing from dirt and dust at least once every six months;
- Observe safety operation rules described in this document;
- Check for the power adapter condition and replace it in a timely manner;
- Repair mechanical damages to the device (in Service Centers).

The **Perenio®** Elegance IoT Router repairs shall be carried out in Service Centers, because casings will have to be opened in the case of any element failure.

In the case of warranty repairs or replacement, the User shall provide the Seller with the sales receipt and the purchased device.

For details on the replacement and repairs of the IoT Router, please contact your local Company representative or the Tech Support Department at **perenio.com**.

5 Warranty Obligations

The warranty period for the IoT Router shall be **Twenty-Four (24) months** from the date of sale to the End User.

The warranty period for components and accessories shall be as follows:

- Built-in batteries: Corresponds to the shelf life of the main device;
- External chargers, cables and other accessories: Six (6) months from the date of sale to the End Customer.

The Warranty Card shall be deemed valid provided that it is correctly and completely filled in by the Seller. Upon the purchase, the Customer shall check that both the Serial Number and the Model name of the device correspond to those indicated in the Warranty Card.

Incomplete or illegible Warranty Card shall be deemed not valid. In this case, it is recommended to contact the Seller and ask for a duly filled in Warranty Card. It shall be also allowed to provide the original of the sales/cashier's receipt or such other documentary evidence of the fact and the date of sale of the device. The date of sale shall be the date indicated on the sales/cashier's receipt or other relevant document. If the date of sale is not possible to be determined, the start of the warranty period shall be the date of manufacture of the device.

The Manufacturer shall guarantee that all materials, components and assemblies of **Perenio[®]** devices are free from defects under normal operation within the warranty period. The limited warranty shall be applied to the first End Customer of **Perenio[®]** devices only and cannot be transferred to a subsequent customer.

For warranty replacement, the device must be returned to the Seller along with its receipt. Warranty obligations for **Perenio[®]** devices shall be provided in the country of their purchase only.

WARRANTY SERVICE PROCEDURE

In the case of any alleged defect or deficiency of the device detected, the Customer shall contact the Authorized Service Center before the warranty period expiration and provide the following:

1. The device with an alleged defect or deficiency.
2. The Warranty Card filled out in accordance with the applicable legal requirements, or the original of the document confirming the purchase of the device, including clear indication of the name and the address of the Seller, as well as the date when this device was sold.

LIMITATION OF LIABILITY

Perenio® devices SHALL NOT BE SUBJECT TO a free warranty service in the case of identification of at least one of the following damages or defects:

- Any damage caused by force majeure, accidents, and willful or careless acts (omissions) of the Customer or third parties;
- Any damage caused by the impact of other objects including but not limited to exposure to moisture, dampness, extreme temperatures or environmental conditions (or jumps in such conditions), corrosion and oxidation, as well as penetration of food or liquid, and the effects of chemicals, animals, insects and byproducts thereof;
- In the event when the device (accessories and/or components) was unsealed (the seal integrity was violated), modified or repaired by any party other than the Authorized Service Center, including repair works using unauthorized spare parts;
- Any defects or damage caused by improper or unintended use of the device, including operation contrary to available manuals;
- Any defects caused by attempts to connect to incompatible software;
- Any defects caused by natural wear and tear of Products, including bags, casings, batteries or Installation and Operation Manuals;
- In the event when the Serial Number (Name Plates), the date of manufacture or the Model name on the device casing was in any way removed, erased, affected, altered or made illegible;
- In the case of violation of operating procedures and conditions, as well as the device installation instructions described in relevant Manuals;
- Cracks, scratches and other defects caused as a result of transportation and/or operation of the device by the Customer or acts of negligence on their part;
- Mechanical damages that occurred after transferal of the device to the Customer including damage caused by sharp objects, bending, squeezing, falling, etc.;
- Any damage caused by non-conformity with the standards of power supply, telecommunication and cable networks or similar external factors.

THE PRESENT LIMITED WARRANTY IS AN EXCLUSIVE AND THE ONLY PROVIDED GUARANTEE THAT SHALL REPLACE ANY OTHER EXPRESS AND IMPLIED GUARANTEES. THE MANUFACTURER SHALL PROVIDE NO GUARANTEES, WHETHER EXPRESS OR IMPLIED, BEYOND THE DESCRIPTION CONTAINED IN THE PRESENT DOCUMENT, INCLUDING THE IMPLIED WARRANTY OF MERCHANTABILITY AND FITNESS FOR A PARTICULAR PURPOSE. THE CUSTOMER MAY USE DEFECTIVE OR INAPPLICABLE DEVICE AT HIS/HER OWN DISCRETION. THE MANUFACTURER SHALL NOT BE RESPONSIBLE FOR DAMAGE TO OTHER PROPERTY CAUSED BY DEVICE DEFECTS, THE LOSS OF USABILITY OR TIME OR FOR ANY SPECIAL, INCIDENTAL, INDIRECT OR CONSEQUENTIAL DAMAGE OR LOSS INCLUDING BUT NOT LIMITED TO COMMERCIAL

LOSS, LOSS OF PROFITS, LOSS OF CONFIDENTIAL OR OTHER INFORMATION, AS WELL AS DAMAGES CAUSED BY BREAKS IN COMMERCIAL OR PRODUCTION ACTIVITIES DUE TO THE FACT THAT THE DEVICE WAS RECOGNIZED AS FAULTY, DEFECTIVE OR NOT ALLOWED FOR USAGE.

The present limited warranty shall provide the Customer with certain legal rights. The Customer may also have other rights in accordance with the local consumer protection laws that vary from country to country and may not coincide with this limited warranty. For full understanding of the Customer's rights, you shall read local acts.

NOTE. The Manufacturer does not produce equipment for *Vital Tasks*. Vital Task Products shall include life support systems, medical equipment, implantation-related medical devices, commercial transportation, nuclear equipment or systems, and any other fields of application where equipment failures may do harm to a humans' health or cause their deaths, as well as result in a property damage.

6 Storage, Transportation and Disposal of Devices

The **Perenio®** IoT Router may be shipped by any kind of covered vehicles (by rail, or road or in sealed heated airplane compartments, etc.) in accordance with the requirements of current regulatory documents applicable to fragile goods sensitive to moisture.

Similar conditions shall apply to the device storage at the Seller's warehouse.

In accordance with the Waste Electrical and Electronic Equipment (WEEE)* regulations, all electrical and electronic products must be collected separately at the end of their service life, and cannot be disposed of together with unsorted household waste.

Parts of worn out devices must be separated and sorted by the material type. In this way, every user can contribute to reuse, recycling and other forms of recovery of waste electrical and electronic equipment. Proper collection, recycling, and disposal of such devices will help avoid potential environmental and health impacts from the harmful substances they contain.

To dispose of the device, it must be returned to the point of sale, or to a local waste collection and recycling company recommended by the state or local authorities. Disposal is carried out in accordance with the applicable laws and regulations of the respective country.

For more details on how to properly dispose of your used device, please contact your device supplier, your waste disposal service or the local authorities responsible for waste disposal.

NOTE. The User must comply with the temperature and humidity conditions of storage and transportation specified in the Table of technical specifications of the present Installation and Operation Manual.

* Waste Electrical and Electronic Equipment, or WEEE, means used electrical or electronic equipment, including all components, assemblies, consumables that are part of the equipment at the time it is taken out of service (including supplied batteries (if any), components containing mercury, etc.).

7 Other Information

Manufacturer

Name	<i>Perenio IoT spol s r.o.</i>
Address	Na Dlouhem 79, Ricany – Jazlovice 251 01, Czech Republic
Contact Info	perenio.com, info@perenio.com

Importing Company

Name	<i>ASBISc Enterprises PLC</i>
Address	Iapetou, 1, Agios Athanasios, 4101, Limassol, Cyprus
Contact Info	Tel.: +357-25-85-70-00, e-mail: info@asbis.com

Info on Certificates and Declarations

Declarations	RoHS Compliance Declaration as of January 28, 2020; EC Declaration of Conformity as of January 28, 2020 (For the full list of declaration, see perenio.com/documents)
--------------	---

Addresses of Service Centers are available at **perenio.com** in the 'Support' Section.

8 Troubleshooting

Table below shows typical errors and problems that may occur in the process of connection and configuration of the **Perenio®** Elegance IoT Router.

Table 10 – Typical Errors and Troubleshooting Methods

Item No	Problem	Possible Reasons	Solution
1	Lack of light indication of the power button after the device is turned on for the first time	Too low battery level	Wait for about 30 minutes (The device must be plugged in to the mains) and try to turn it on again
2	LED indicators are not blinking after turning on the device	LED indication failure	Reboot the device by pressing and holding the reset button for 2 seconds while the IoT Router is powered on
3	The power button starts blinking red fast unexpectedly	Overheating of the device	Change the device location, turn it off and let cool down
4	The device is connected to the mains, but powered by the built-in battery	The power adapter cable is connected incorrectly (not fully inserted)	Unplug the power adapter cable from the port and connect it again
		Unsupported power adapter is used	Replace the power adapter with the original one
5	Devices connected to the IoT Router via cable have no access to the Internet	Ethernet cable is defective	Replace the Ethernet cable
		Ethernet cable is plugged into the wrong port	Plug the Ethernet cable into a suitable port
		The IoT Router or the device port is defective	Contact Technical Support Department

Item No	Problem	Possible Reasons	Solution
6	LTE connection does not work	SIM card issues, or the device is connected via WAN	Check the operability of the SIM card or the coverage area
		SIM card has zero balance, so Internet access is denied	Refill the SIM card balance
7	SIM card is not recognized after being inserted	Failure to follow SIM card instructions	See par. 2.1.6 of this document
8	After rebooting/ updating the device, the Internet connection via LTE was lost	PIN code was not disabled during LTE connection setup	Disable the use of PIN Code (See par. 9.5 of this document)
9	IoT Router does not switch between different Internet sources	Wrong connection priority setting	See par. 3.9.6 of this document
10	5GHz Access Point is not displayed in the list of available Wi-Fi Networks on a mobile device	This Access Point is disabled by the User	See par. 2.10 of this document
		This Access Point is used as Client for the Wi-Fi Client Mode	Connect to 2.4GHz Access Point or reset settings of the Wi-Fi Client Mode
		Used channel is blocked in the country of residence of the User	See note in par. 2.10 of this document

9 Frequently Asked Questions

It is recommended to read the below references carefully in order to get answers to typical questions arising during operation of the Elegance IoT Router more easily.

9.1 Safety Operation Rules

See [par. 1.6 Safe Operation Rules](#), as well as [Warnings and Restrictions](#) Section of the present manual.

9.2 Cabling

See Figure 10 in [par. 2.1.2 Initial Setting-Up](#) and [par. 2.3 Ethernet Connection](#) of the present manual.

9.3 Battery Operation

See [par. 1.2.3 Built-In Battery](#), [par. 3.6.1 Basic Buttons and Indicators](#) and [Warnings and Restrictions](#) of the present manual of the present manual.

9.4 Remote Reset

See [par. 3.2 Top Panel](#), [par. 3.7.3 Backup/Flashing](#) and [par. 3.10.1 Account](#) of the present manual.

9.5 SIM Card Configuration and Disabling the PIN Code

See 3G/4G Connection description in [par. 2.1.2 Initial Setting-Up](#), [par. 2.1.7 Inserting Nano-SIM Card](#) and [par. 3.9.3 Modem](#) of the present manual.

9.6 Changing Wi-Fi Network Name and Password

See [par. 3.9.2 Wi-Fi](#) of the present manual.

9.7 Sharing USB Flash Files

See [par. 2.7 The Use of USB Storage Devices](#) and [par. 3.8.1 Network Resources](#) of the present manual.

9.8 Time Zone and Time Synchronization

See [par. 3.7.1 System](#) of the present manual.

9.9 Using Multiple Internet Connections

See [par. 3.9.6 WAN Traffic Balancing](#) of the present manual.

9.10 Priority for Multiple Internet Connections

See [par. 3.9.6 WAN Traffic Balancing](#) of the present manual.

9.11 Activating the Device in the Mobile Application

See [par. 2.1.4 Activation in the Perenio Smart App](#), [par. 2.1.8 Activation of the IoT Router in the Perenio Smart App](#) and [par. 3.10 IoT Tab](#) of the present manual.

9.12 Activating the device in Another Account in the Mobile App

See [par. 3.10 IoT Tab](#) of the present manual.

9.13 Removing Device from Account in the Mobile App

See [par. 3.10.1 Account](#) of the present manual.

9.14 Log Downloading

See [par. 2.9 Log Downloading](#) of the present manual.

9.15 Disabling the Access Point

See [par. 2.10 Management of Wi-Fi Access Points](#) of the present manual.

9.16 Manual Selection of the 3G Mode

See [par. 3.9.3 Modem](#) (Step 6) of the present manual.

10 Glossary

Bluetooth	A wireless personal area network specification that allows devices to exchange data on a free radio frequency for short-range communications
IoT	The Internet of Things is a system of Internet-connected devices able to collect and exchange data coming from built-in services
IoT Router	A device that combines the functions of a Wi-Fi and / or LTE router and a Perenio [®] control center
IP30	Degree of protection of the device, indicating that the parts inside the case are protected from the penetration of objects and solid bodies larger than 2.5 mm. No moisture protection. Suitable for unheated rooms
ISP	Internet Service Provider
LAN	Local area network built on the basis of wireless technologies
Location	General designation of a building or premises where the Perenio[®] Control Gateway
LTE	High-speed wireless data transmission standard for mobile and other data-handling devices
Perenio Smart	Software developed by <i>Perenio IoT</i> for remote control of devices from smartphones
QR Code	The quick response code which represents a matrix barcode containing information about the object to which it is linked
RTC	The Real Time Clock is an electronic circuit for tracking the current time, date, day of the week, etc. As a rule, such a circuit has a self-contained power supply, which ensures operation even when the main device is turned off
WAN	Global computer network covering large areas
WPS	A semi-automatic Wi-Fi wireless network standard designed to simplify the wireless setup process
ZigBee	A network protocol designed for secure transmission of data at low speeds, which is recognized for an extremely low power consumption
Z-Wave	Low power wireless communication protocol designed for remote control of consumer electronics and various smart home devices

perenio®
Making life easy